

29334 E FAG

Spherical roller thrust bearings

TYPE: Roller bearings, Thrust roller bearing, Axial spherical

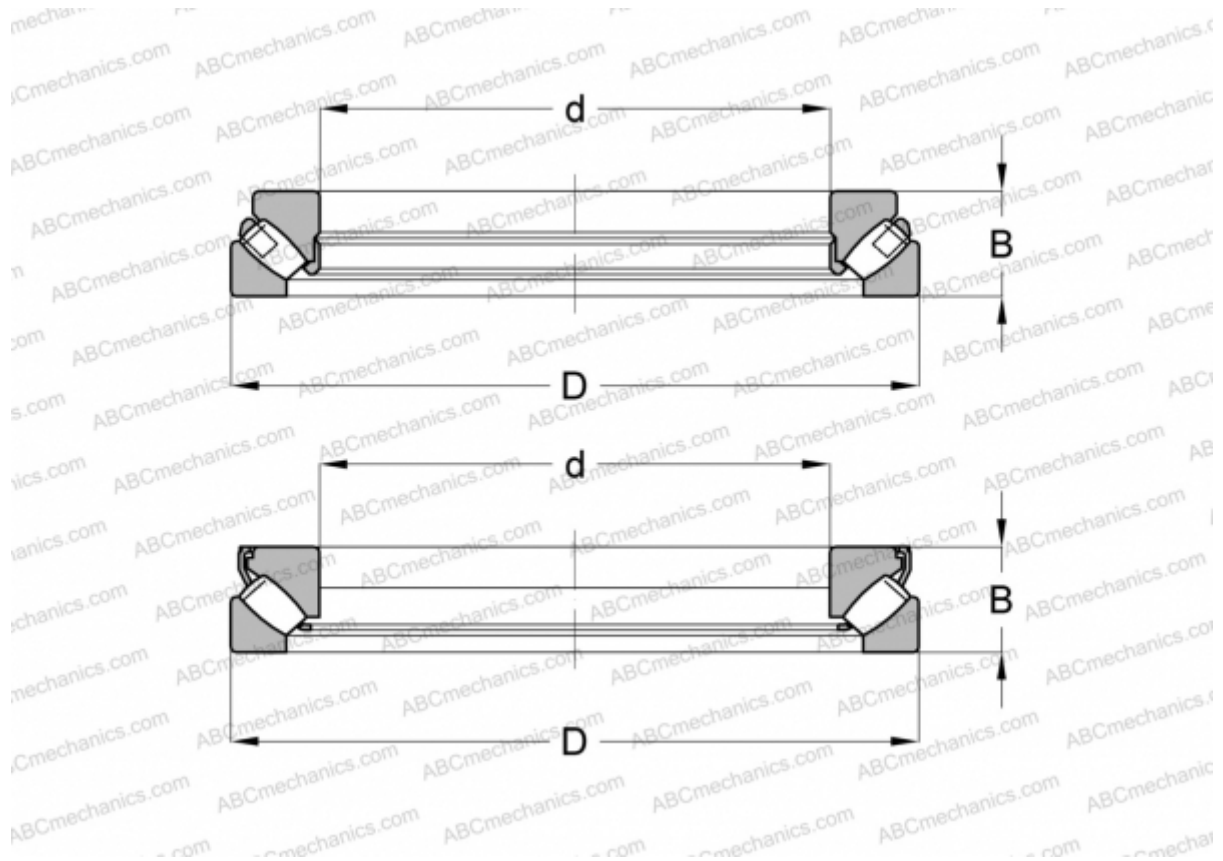

Technical specification

DIMENSIONS, MM

d	170,000
D	280,000
B	67,000

WEIGHT, KG 16,602

MANUFACTURER [FAG](#)

INTERCHANGE

ABC	29334E
SKF	29334 E
TORRINGTON	29334