

## 29334 E SKF

Spherical roller thrust bearings

TYPE: Roller bearings, Thrust roller bearing, Axial spherical

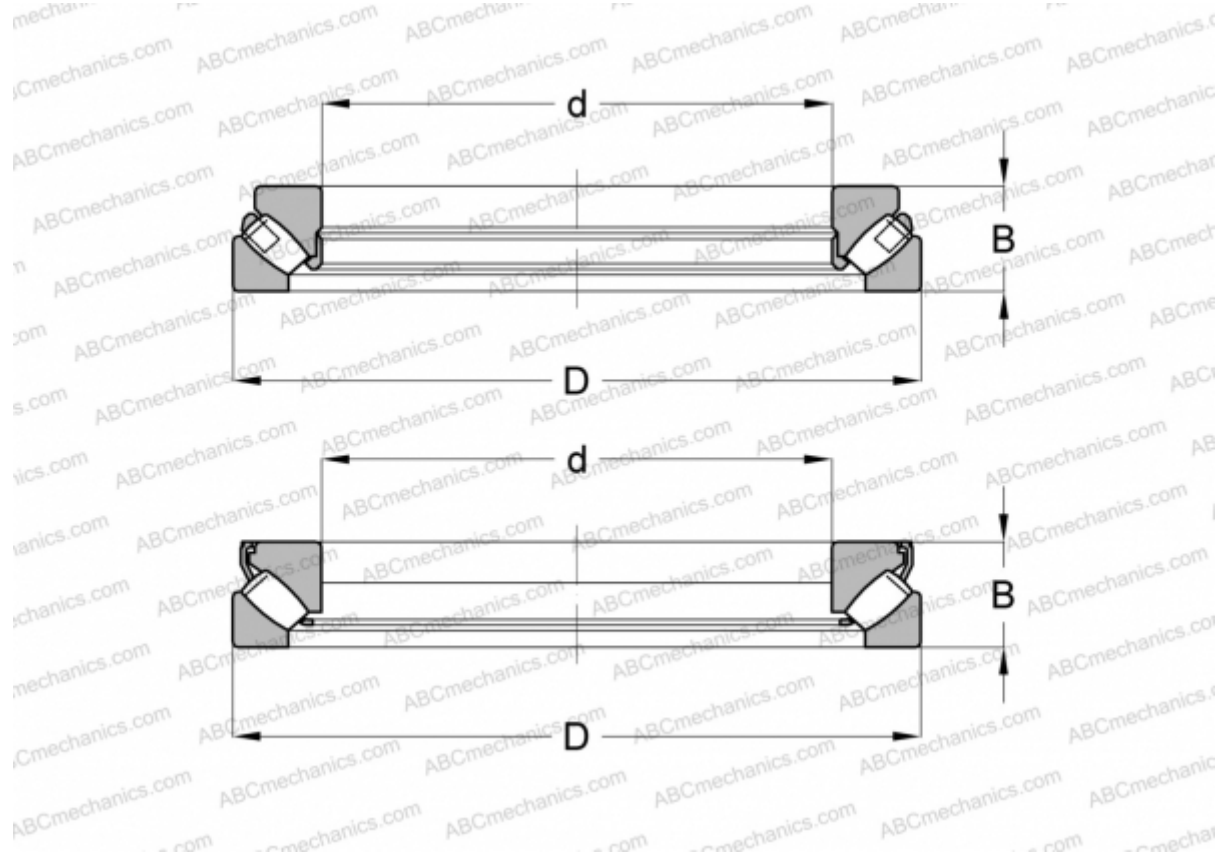

### Technical specification

#### DIMENSIONS, MM

d	170,000
D	280,000
B	67,000

**WEIGHT, KG** 15,000

**MANUFACTURER** [SKF](#)

#### INTERCHANGE

ABC	<a href="#">29334E</a>
FAG	<a href="#">29334 E</a>
TORRINGTON	<a href="#">29334</a>

#### CALCULATION DATA

Basic dynamic load rating, C	1200,000 kN
Basic static load rating, Co	3550,000 kN
Fatigue load limit, Pu	365,000 kN

#### CALCULATION DATA

Reference speed	1300 r/min
Limiting speed	2200 r/min