

29436E ABC

Spherical roller thrust bearings

TYPE: Roller bearings, Thrust roller bearing, Axial spherical

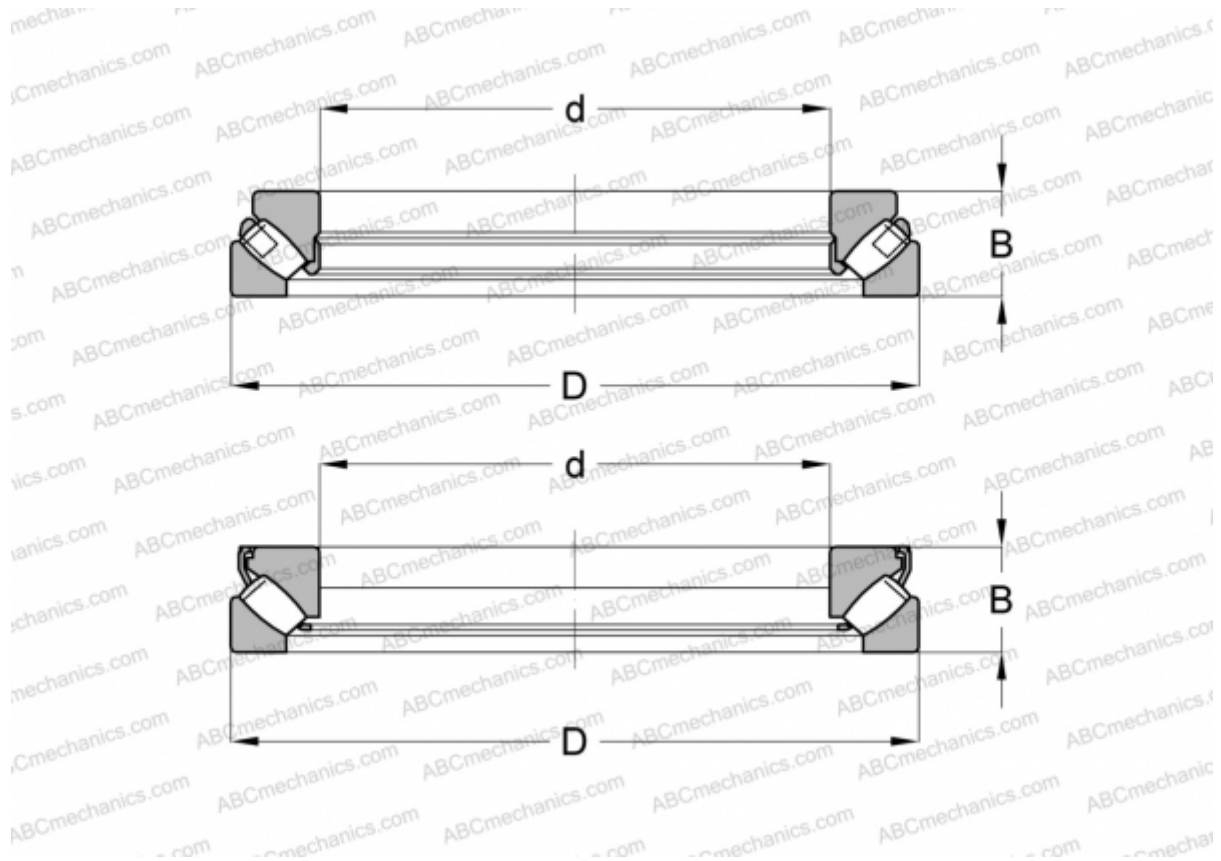

Technical specification

DIMENSIONS, MM

d	180,000
D	360,000
B	109,000

WEIGHT, KG 44,996

MANUFACTURER [ABC](#)

INTERCHANGE

FAG	29436 E
SKF	29436 E