

29436 E FAG

Spherical roller thrust bearings

TYPE: Roller bearings, Thrust roller bearing, Axial spherical

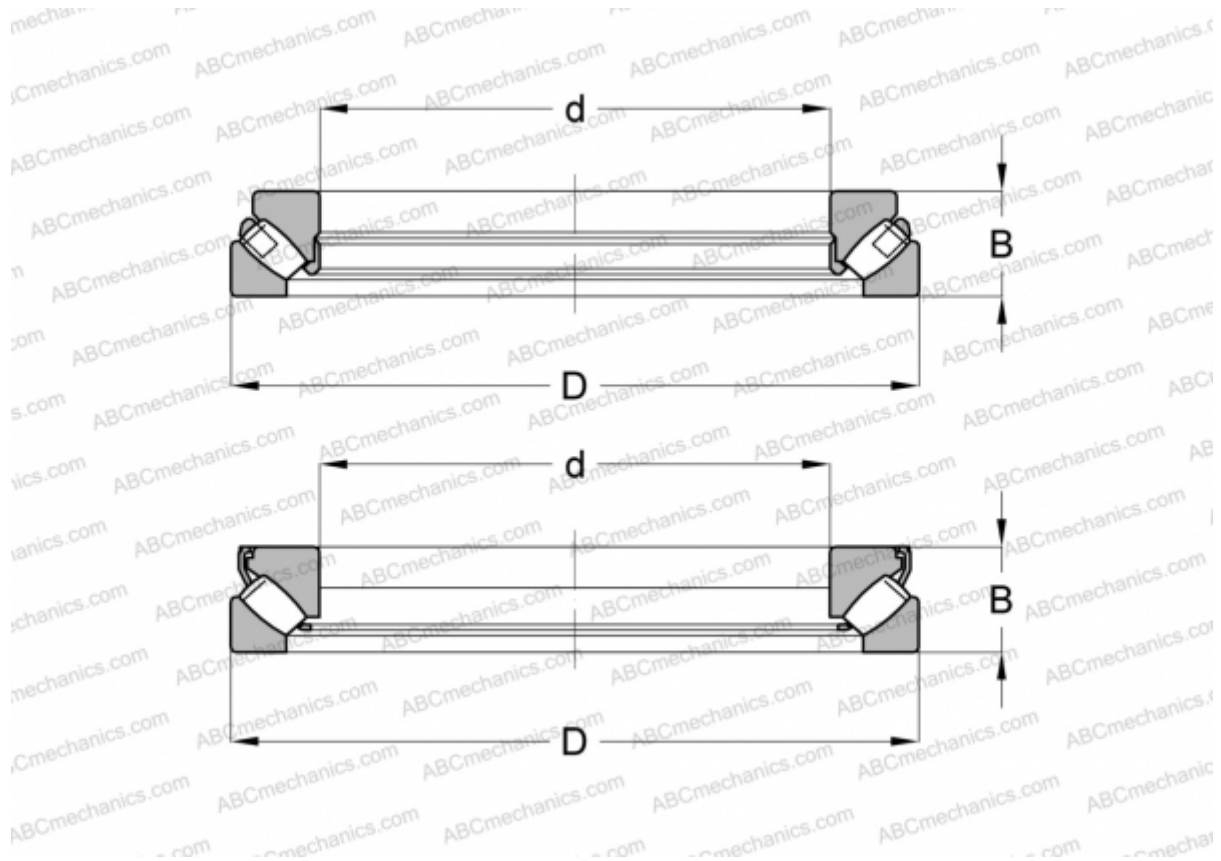

Technical specification

DIMENSIONS, MM

d	180,000
D	360,000
B	109,000

WEIGHT, KG 44,996

MANUFACTURER [FAG](#)

INTERCHANGE

ABC	29436E
SKF	29436 E