

29338 E FAG

Spherical roller thrust bearings

TYPE: Roller bearings, Thrust roller bearing, Axial spherical

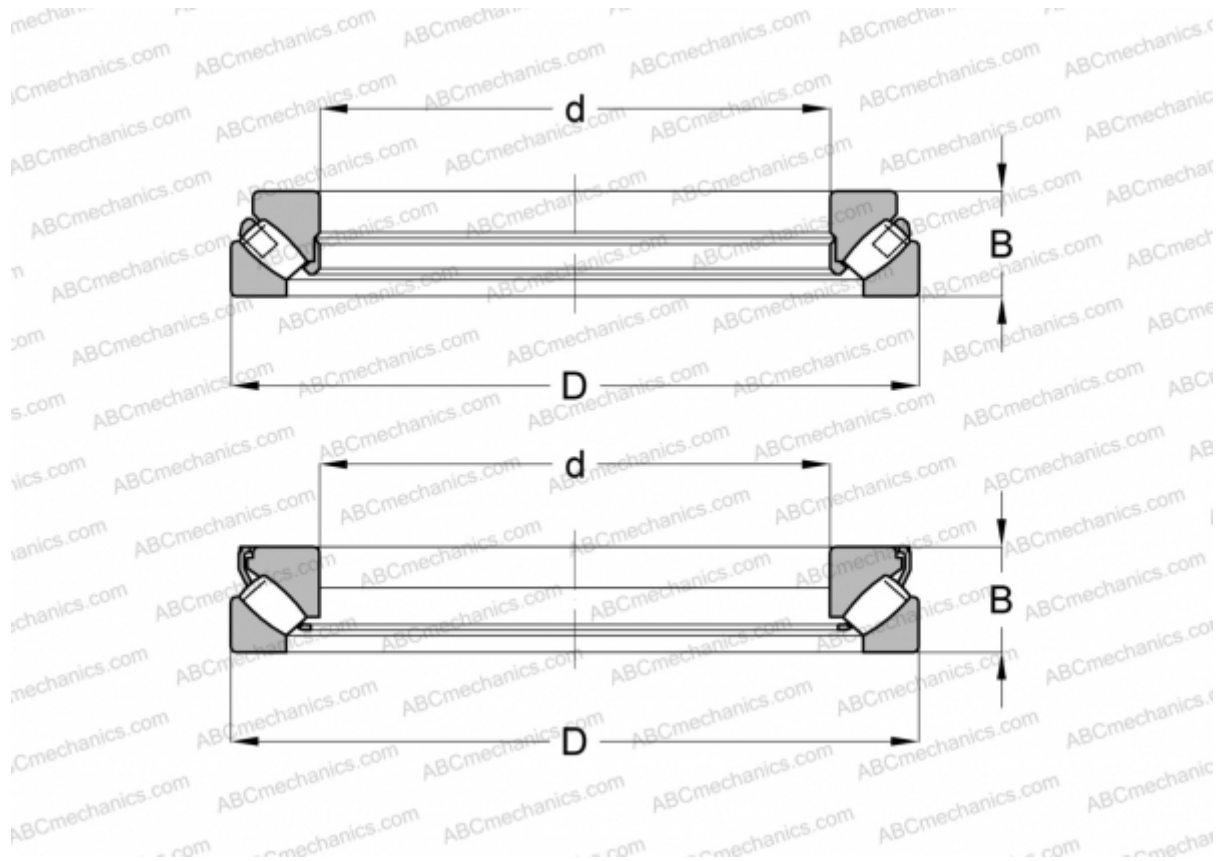

Technical specification

DIMENSIONS, MM

d	190,000
D	320,000
B	78,000

WEIGHT, KG 22,453

MANUFACTURER [FAG](#)

INTERCHANGE

ABC	29338E
SKF	29338 E
TORRINGTON	29338