

29338 E SKF

Spherical roller thrust bearings

TYPE: Roller bearings, Thrust roller bearing, Axial spherical

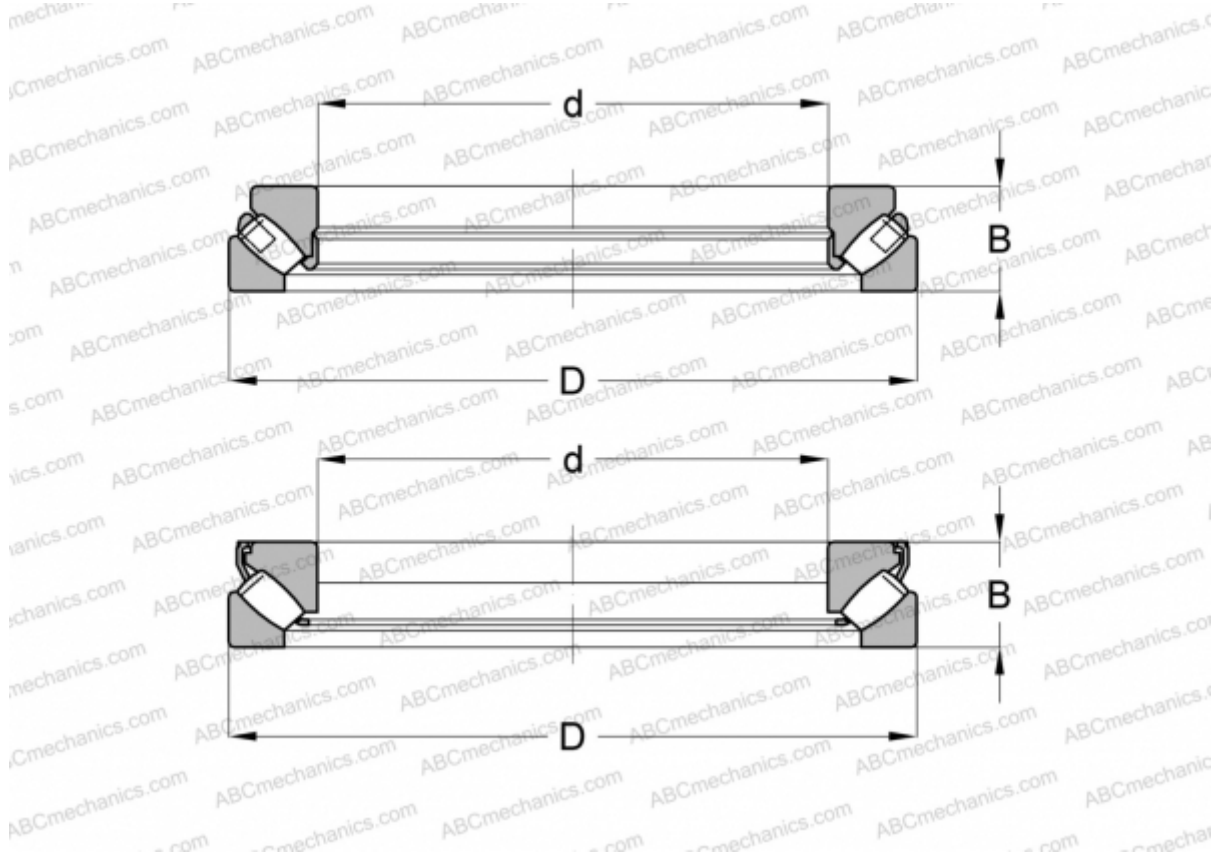

Technical specification

DIMENSIONS, MM

d	190,000
D	320,000
B	78,000

WEIGHT, KG 23,500

MANUFACTURER [SKF](#)

INTERCHANGE

ABC	29338E
FAG	29338 E
TORRINGTON	29338

CALCULATION DATA

Basic dynamic load rating, C	1630,000 kN
Basic static load rating, Co	4750,000 kN
Fatigue load limit, Pu	490,000 kN

CALCULATION DATA

Reference speed	1100 r/min
Limiting speed	1900 r/min