

29340E ABC

Spherical roller thrust bearings

TYPE: Roller bearings, Thrust roller bearing, Axial spherical

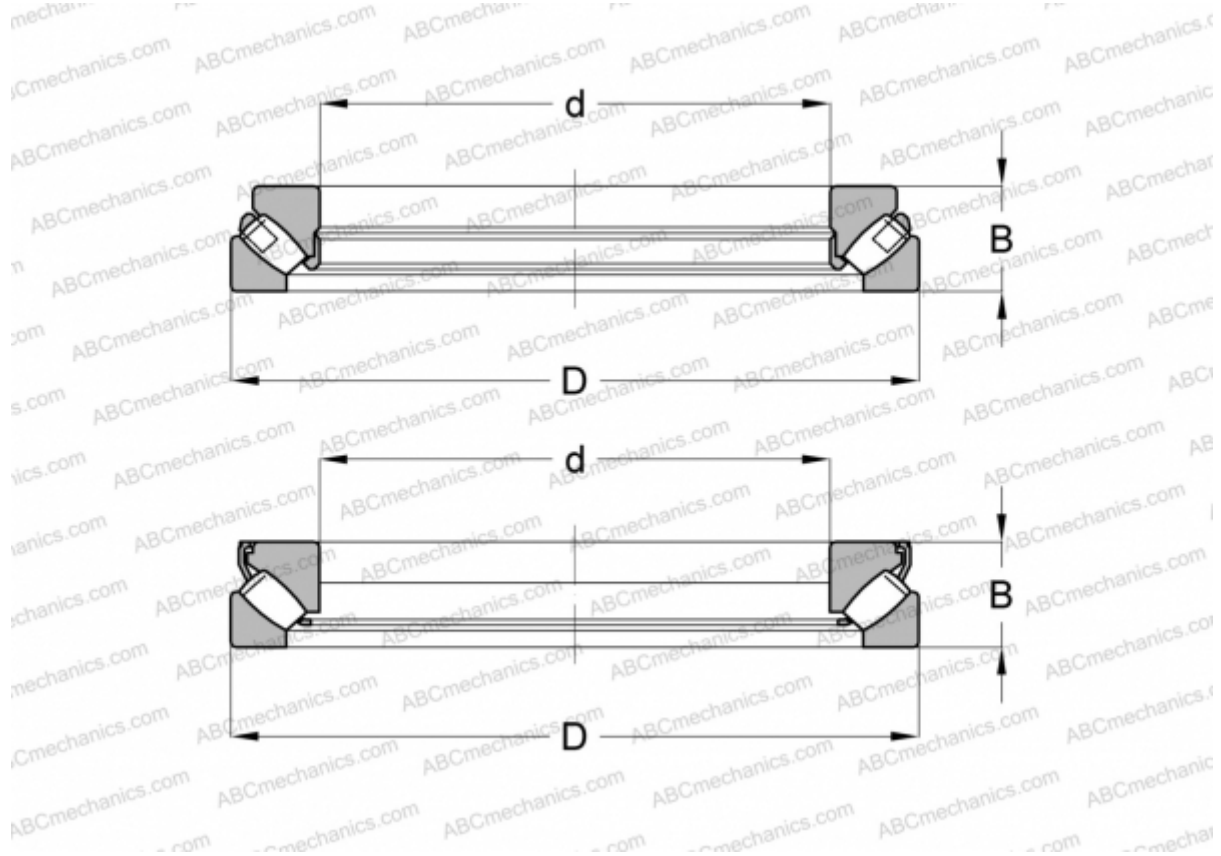

Technical specification

DIMENSIONS, MM

d	200,000
D	340,000
B	85,000

WEIGHT, KG 31,888

MANUFACTURER [ABC](#)

INTERCHANGE

FAG	29340 E
SKF	29340 E
TORRINGTON	29340