

29340 TORRINGTON

Spherical roller thrust bearings

TYPE: Roller bearings, Thrust roller bearing, Axial spherical

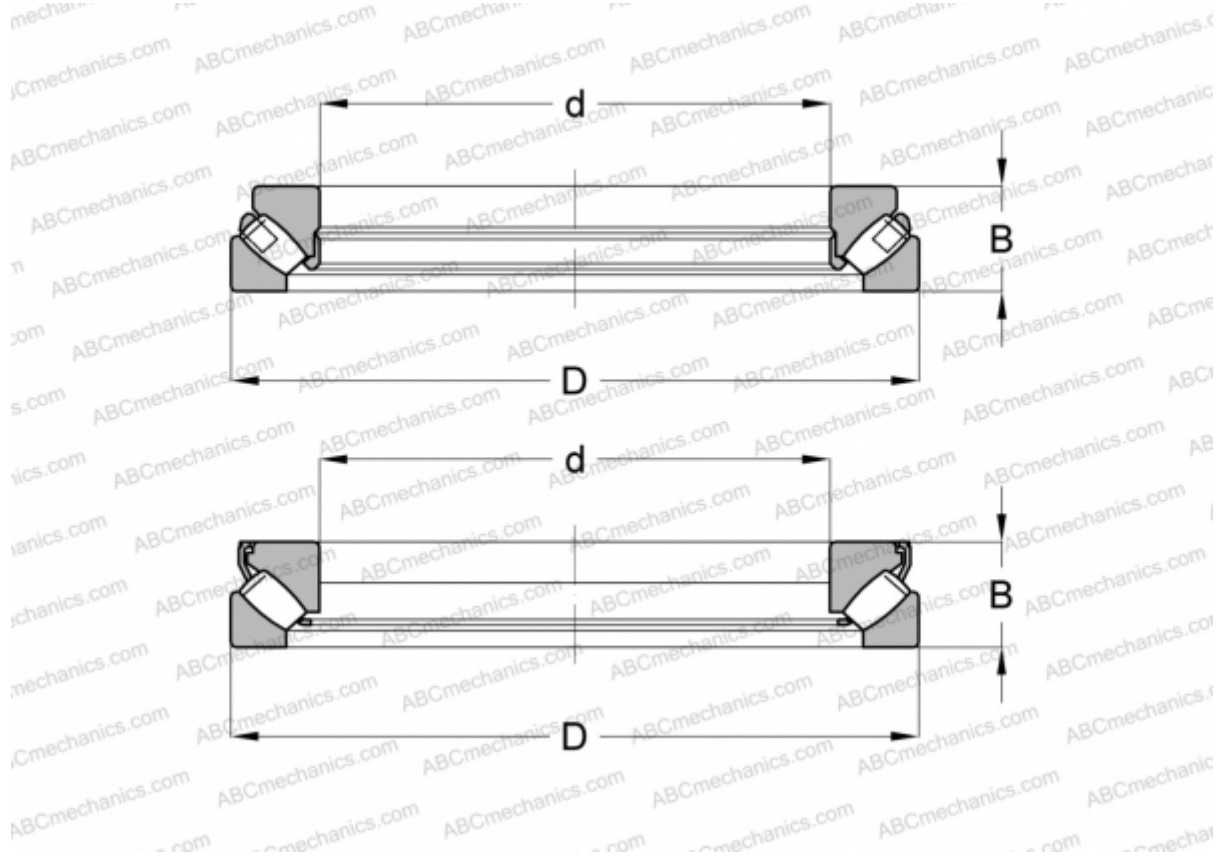

Technical specification

DIMENSIONS, MM

d	200,000
D	340,000
B	85,000

WEIGHT, KG 31,888

MANUFACTURER [TORRINGTON](#)

INTERCHANGE

ABC	29340E
FAG	29340 E
SKF	29340 E