

29360 E SKF

Spherical roller thrust bearings

TYPE: Roller bearings, Thrust roller bearing, Axial spherical

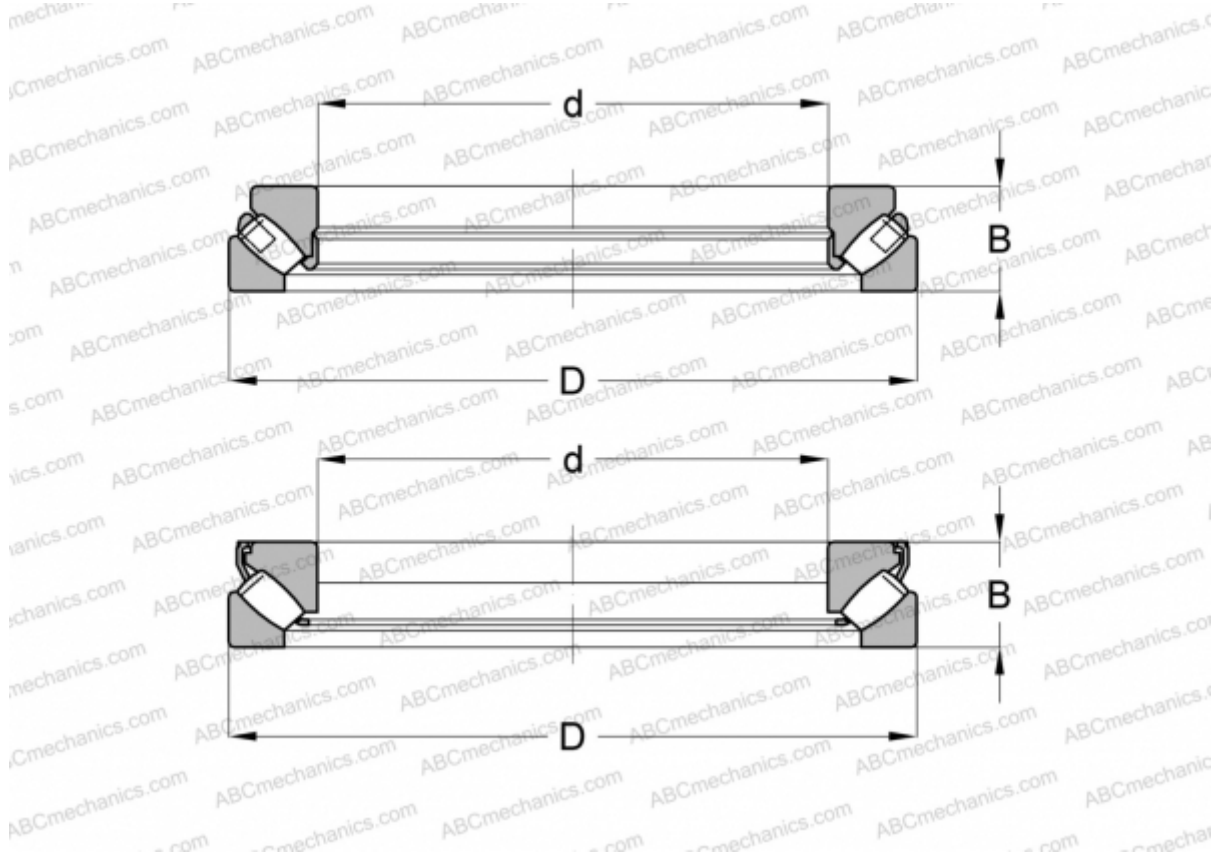

Technical specification

DIMENSIONS, MM

d	300,000
D	480,000
B	109,000

WEIGHT, KG 75,000

MANUFACTURER [SKF](#)

INTERCHANGE

ABC	29360E M
FAG	29360 E.MB
TORRINGTON	29360

CALCULATION DATA

Basic dynamic load rating, C	3100,000 kN
Basic static load rating, Co	10600,000 kN
Fatigue load limit, Pu	930,000 kN

CALCULATION DATA

Reference speed	750 r/min
Limiting speed	1200 r/min