

29360 TORRINGTON

Spherical roller thrust bearings

TYPE: Roller bearings, Thrust roller bearing, Axial spherical

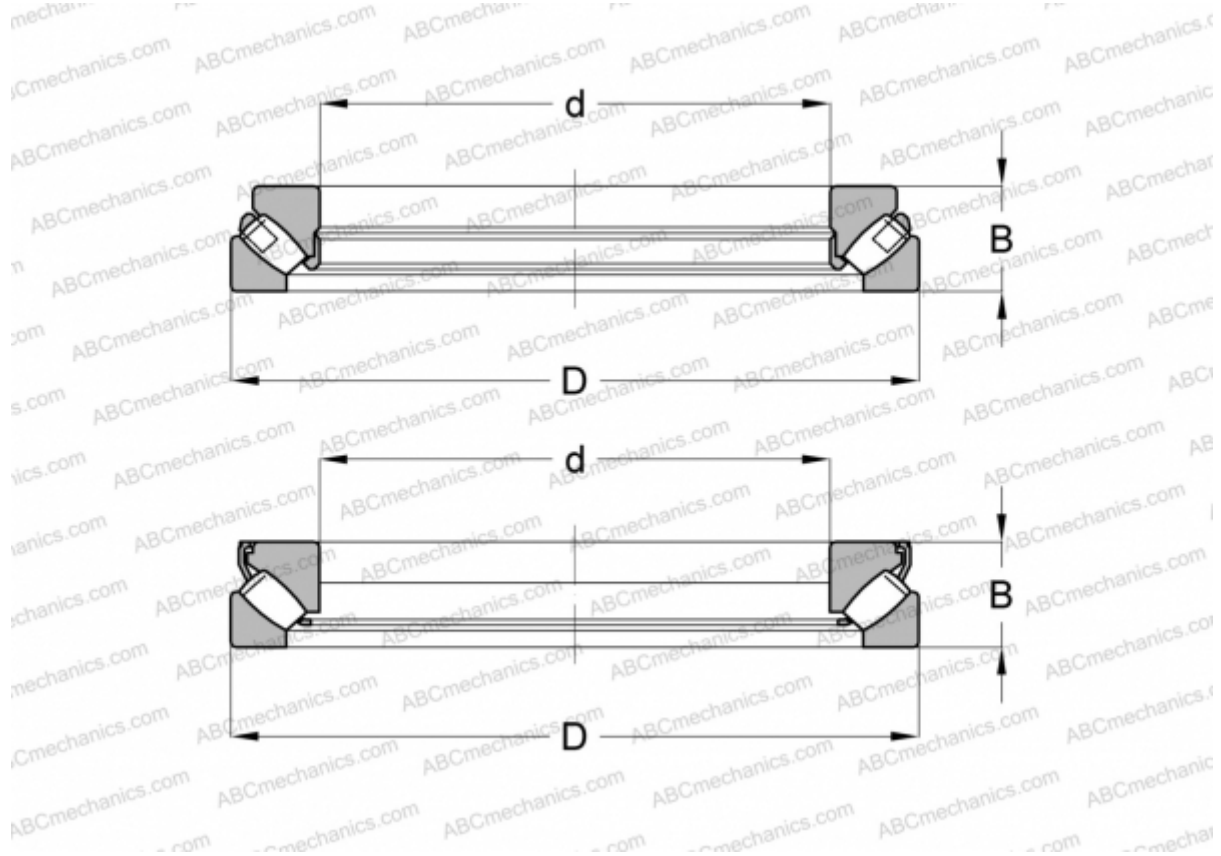

Technical specification

DIMENSIONS, MM

d	300,000
D	480,000
B	109,000

WEIGHT, KG 68,492

MANUFACTURER [TORRINGTON](#)

INTERCHANGE

ABC	29360E M
FAG	29360 E.MB
SKF	29360 E