

29460E M ABC

Spherical roller thrust bearings

TYPE: Roller bearings, Thrust roller bearing, Axial spherical

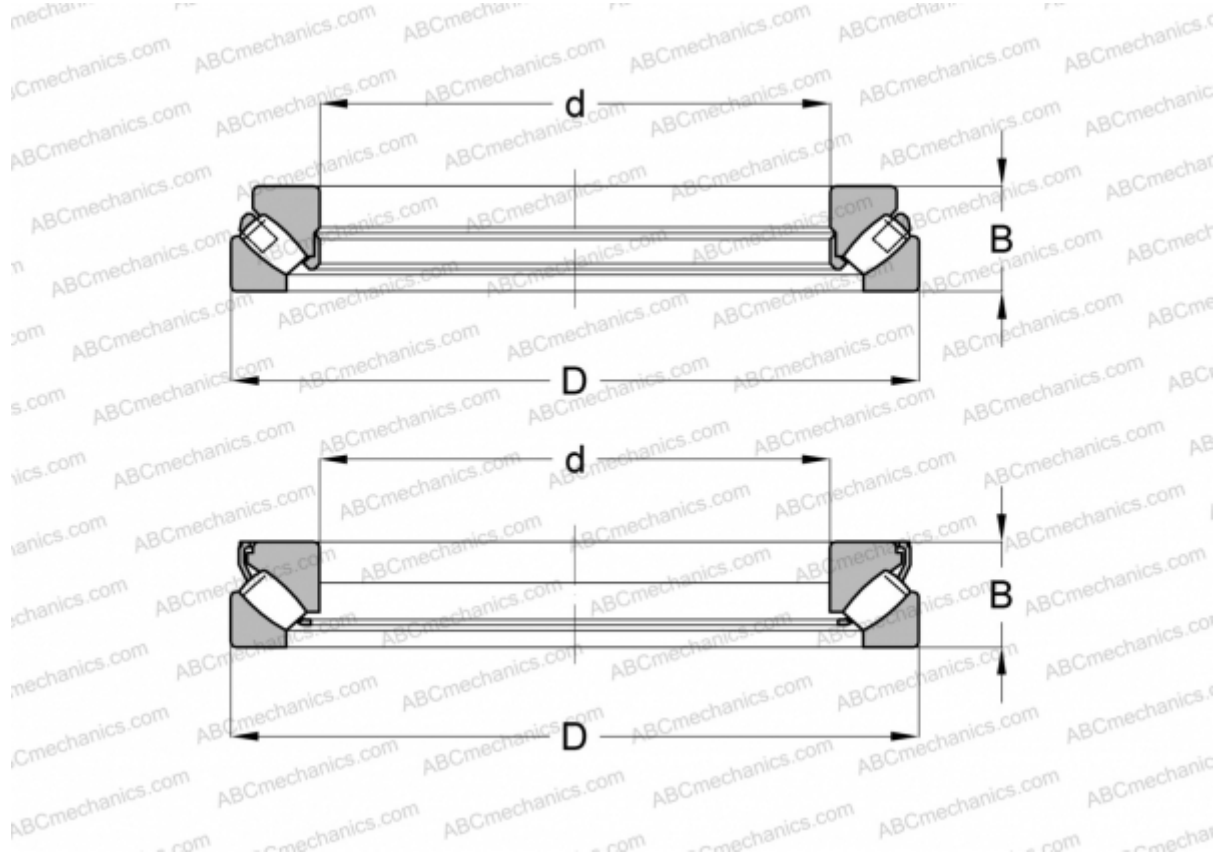

Technical specification

DIMENSIONS, MM

d	300,000
D	540,000
B	145,000

WEIGHT, KG 132,902

MANUFACTURER [ABC](#)

INTERCHANGE

FAG	29460 E.MB
SKF	29460 E
TORRINGTON	29460