

29264 SKF

Spherical roller thrust bearings

TYPE: Roller bearings, Thrust roller bearing, Axial spherical

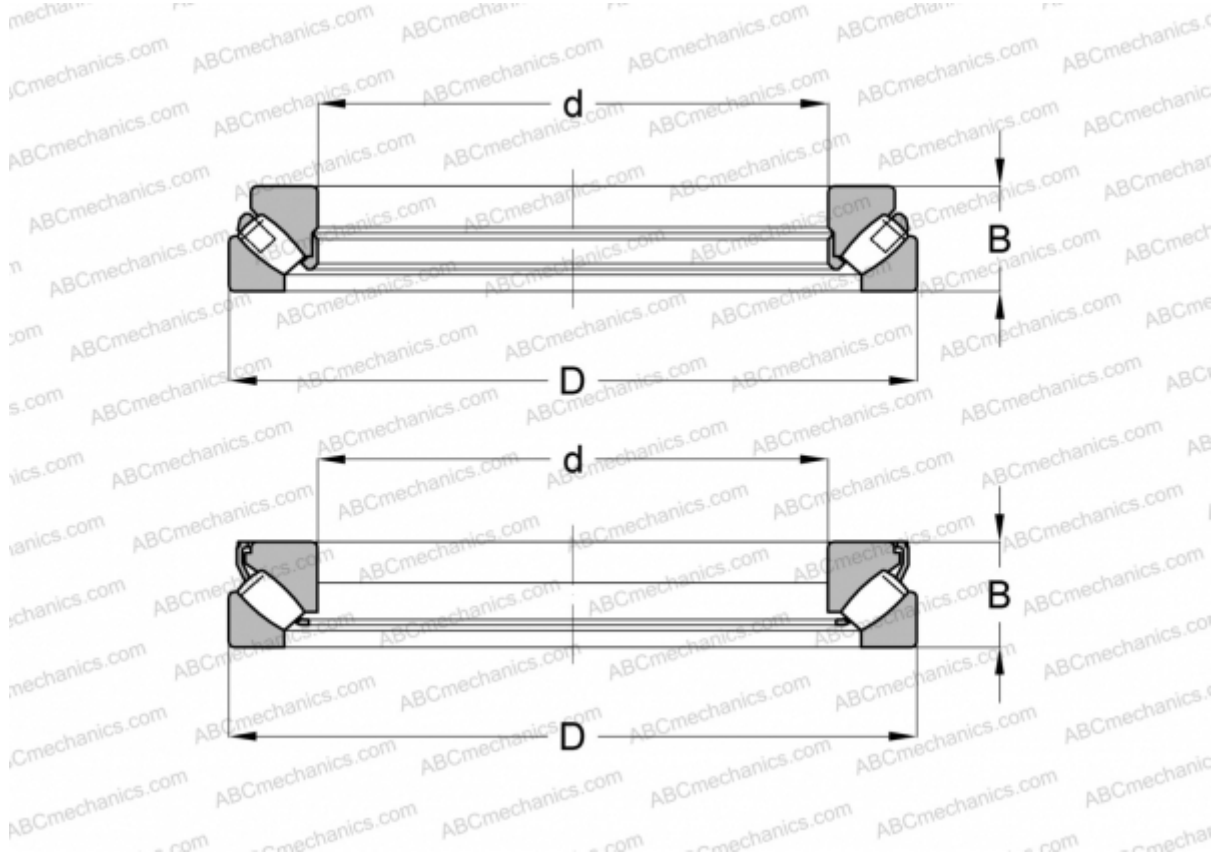

Technical specification

DIMENSIONS, MM

d	320,000
D	440,000
B	73,000

WEIGHT, KG 33,000

MANUFACTURER [SKF](#)

INTERCHANGE

ABC	29264E M
FAG	29264 E.MB

CALCULATION DATA

Basic dynamic load rating, C	1110,000 kN
Basic static load rating, Co	5100,000 kN
Fatigue load limit, Pu	465,000 kN
Reference speed	850 r/min

CALCULATION DATA

Limiting speed	1400 r/min
----------------	------------