

29364 E SKF

Spherical roller thrust bearings

TYPE: Roller bearings, Thrust roller bearing, Axial spherical

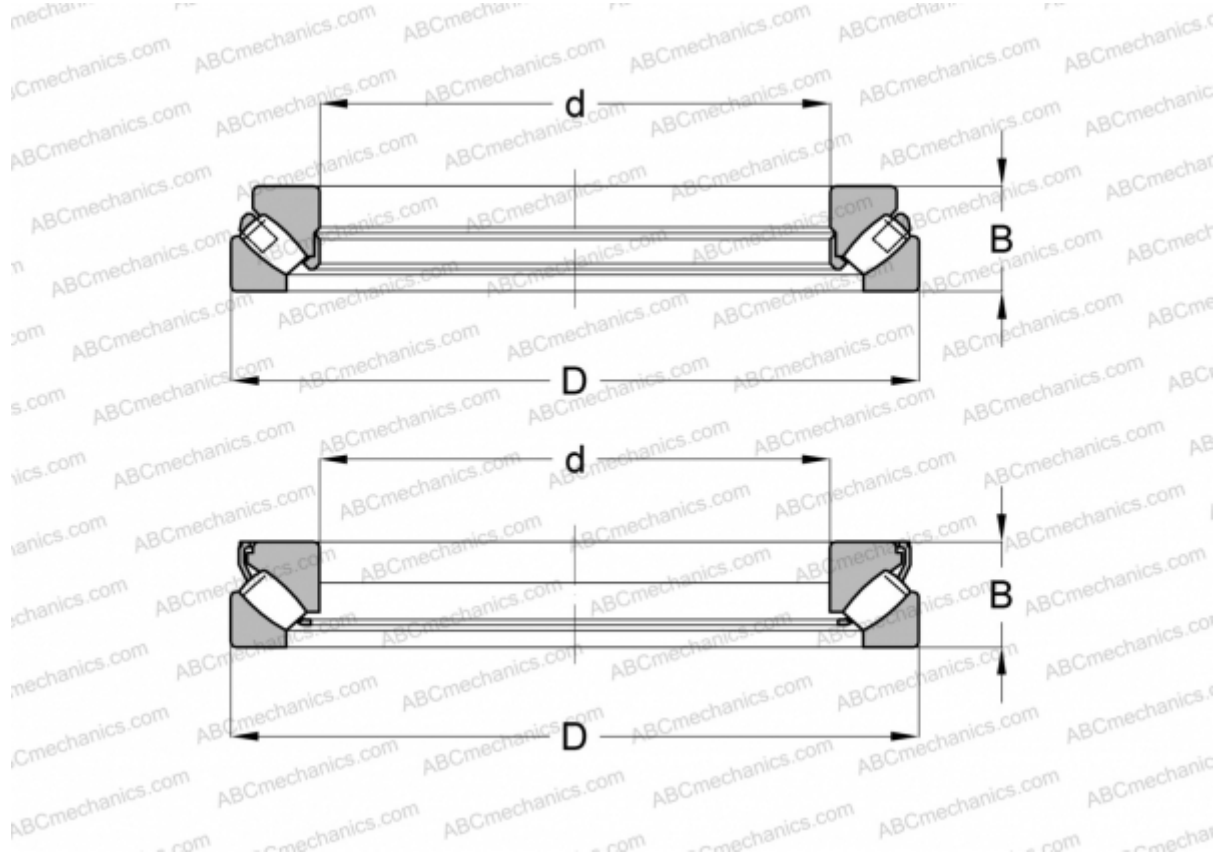

Technical specification

DIMENSIONS, MM

d	320,000
D	500,000
B	109,000

WEIGHT, KG 78,000

MANUFACTURER [SKF](#)

INTERCHANGE

ABC	29364E M
FAG	29364 E.MB
TORRINGTON	29364

CALCULATION DATA

Basic dynamic load rating, C	3350,000 kN
Basic static load rating, Co	11200,000 kN
Fatigue load limit, Pu	1000,000 kN

CALCULATION DATA

Reference speed	750 r/min
Limiting speed	1200 r/min