

29364 TORRINGTON

Spherical roller thrust bearings

TYPE: Roller bearings, Thrust roller bearing, Axial spherical

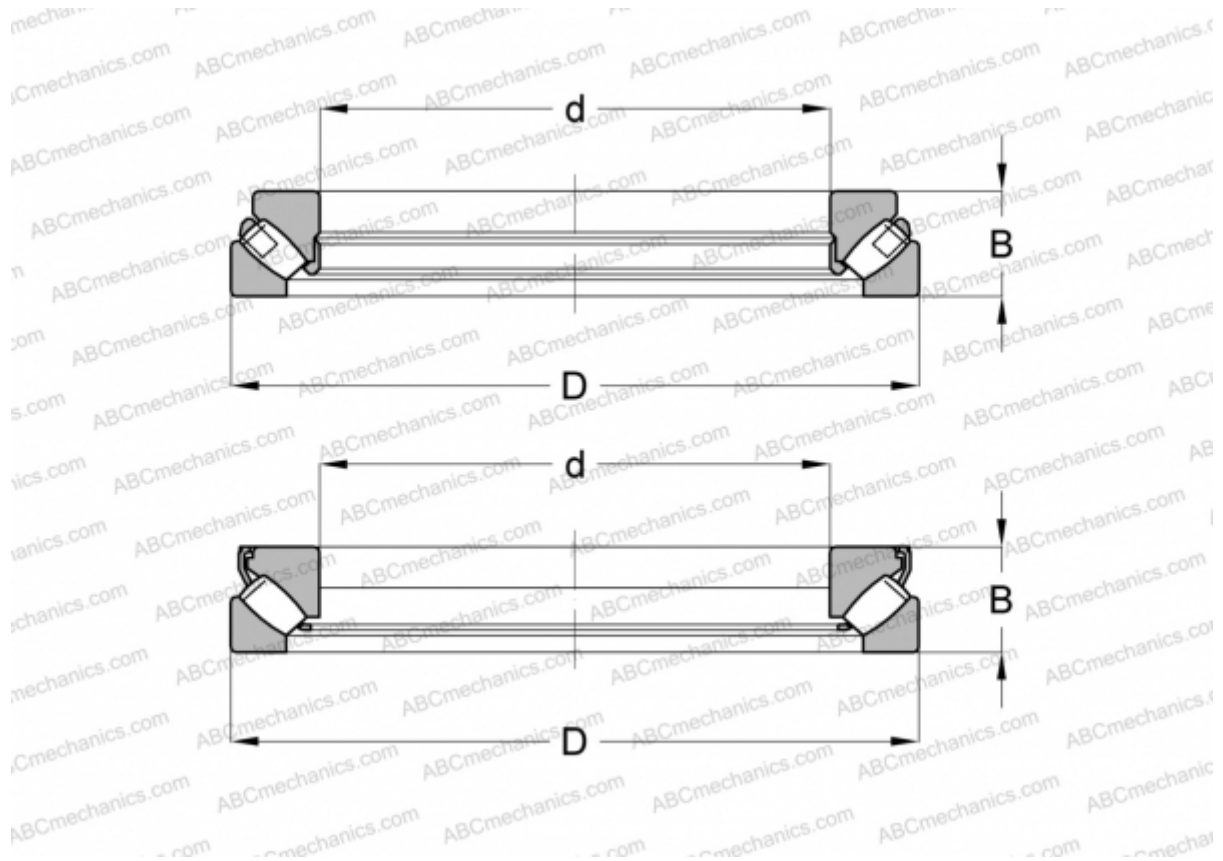

Technical specification

DIMENSIONS, MM

d	320,000
D	500,000
B	109,000

WEIGHT, KG 79,379

MANUFACTURER [TORRINGTON](#)

INTERCHANGE

ABC	29364E M
FAG	29364 E.MB
SKF	29364 E