

29268E M ABC

Spherical roller thrust bearings

TYPE: Roller bearings, Thrust roller bearing, Axial spherical

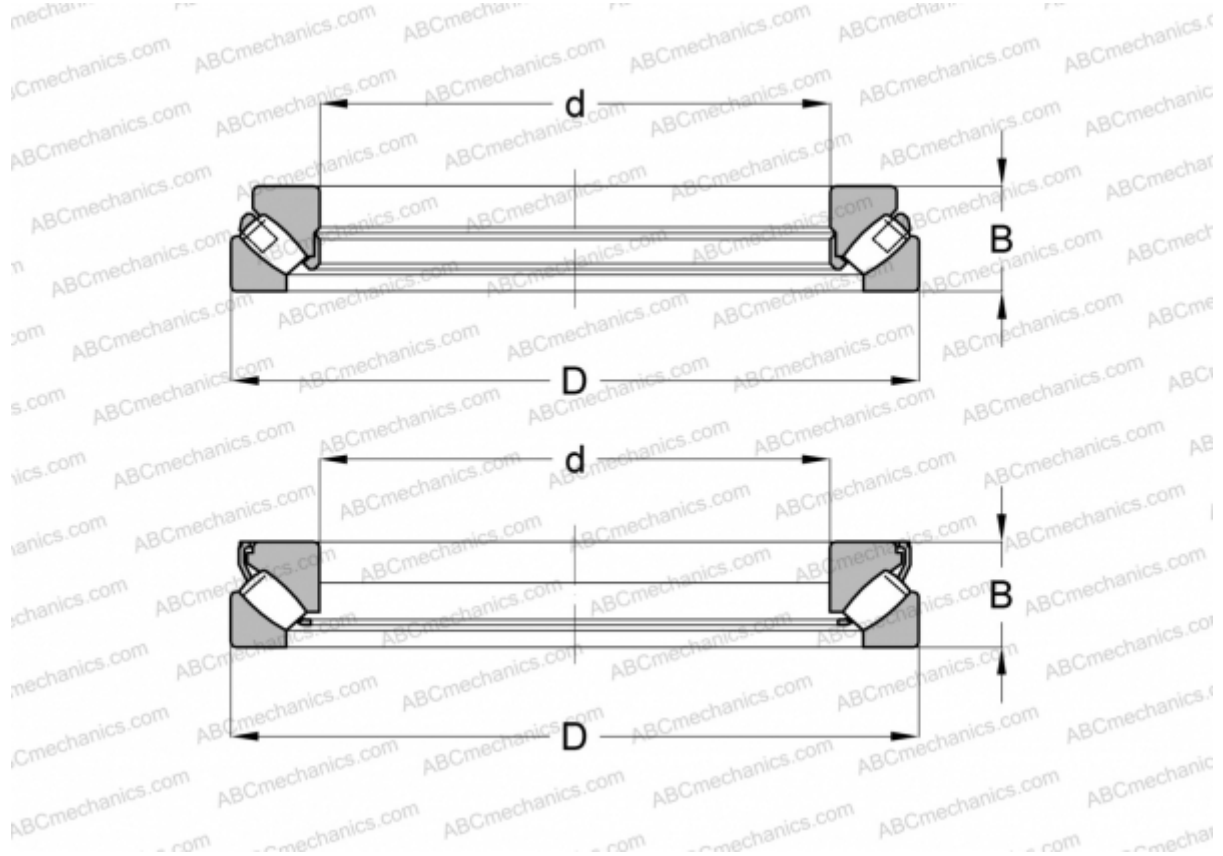

Technical specification

DIMENSIONS, MM

d	340,000
D	460,000
B	73,000

WEIGHT, KG 31,706

MANUFACTURER [ABC](#)

INTERCHANGE

FAG	29268 E.MB
SKF	29268