

29268 SKF

Spherical roller thrust bearings

TYPE: Roller bearings, Thrust roller bearing, Axial spherical

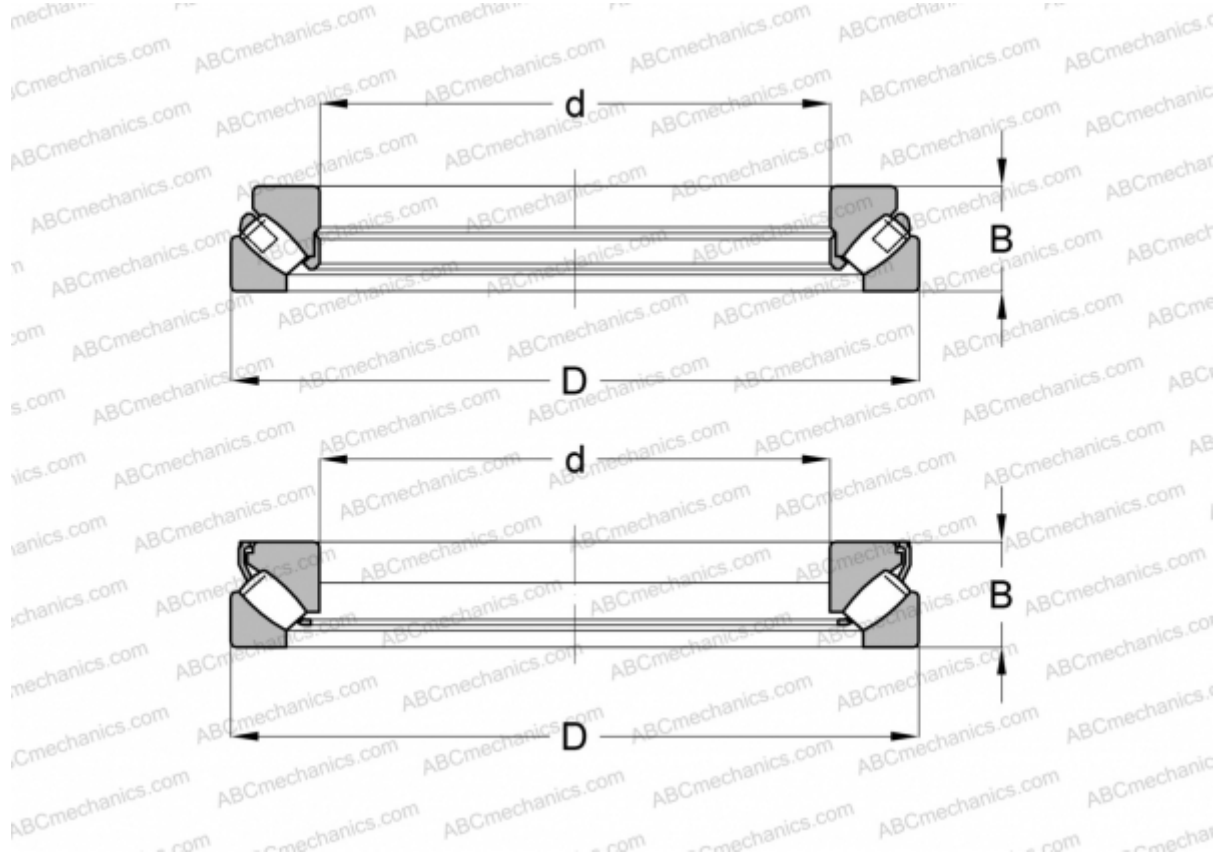

Technical specification

DIMENSIONS, MM

d	340,000
D	460,000
B	73,000

WEIGHT, KG 33,500

MANUFACTURER [SKF](#)

INTERCHANGE

ABC	29268E M
FAG	29268 E.MB

CALCULATION DATA

Basic dynamic load rating, C	1130,000 kN
Basic static load rating, Co	5400,000 kN
Fatigue load limit, Pu	480,000 kN
Reference speed	850 r/min

CALCULATION DATA

Limiting speed	1300 r/min
----------------	------------