

29468 E SKF

Spherical roller thrust bearings

TYPE: Roller bearings, Thrust roller bearing, Axial spherical

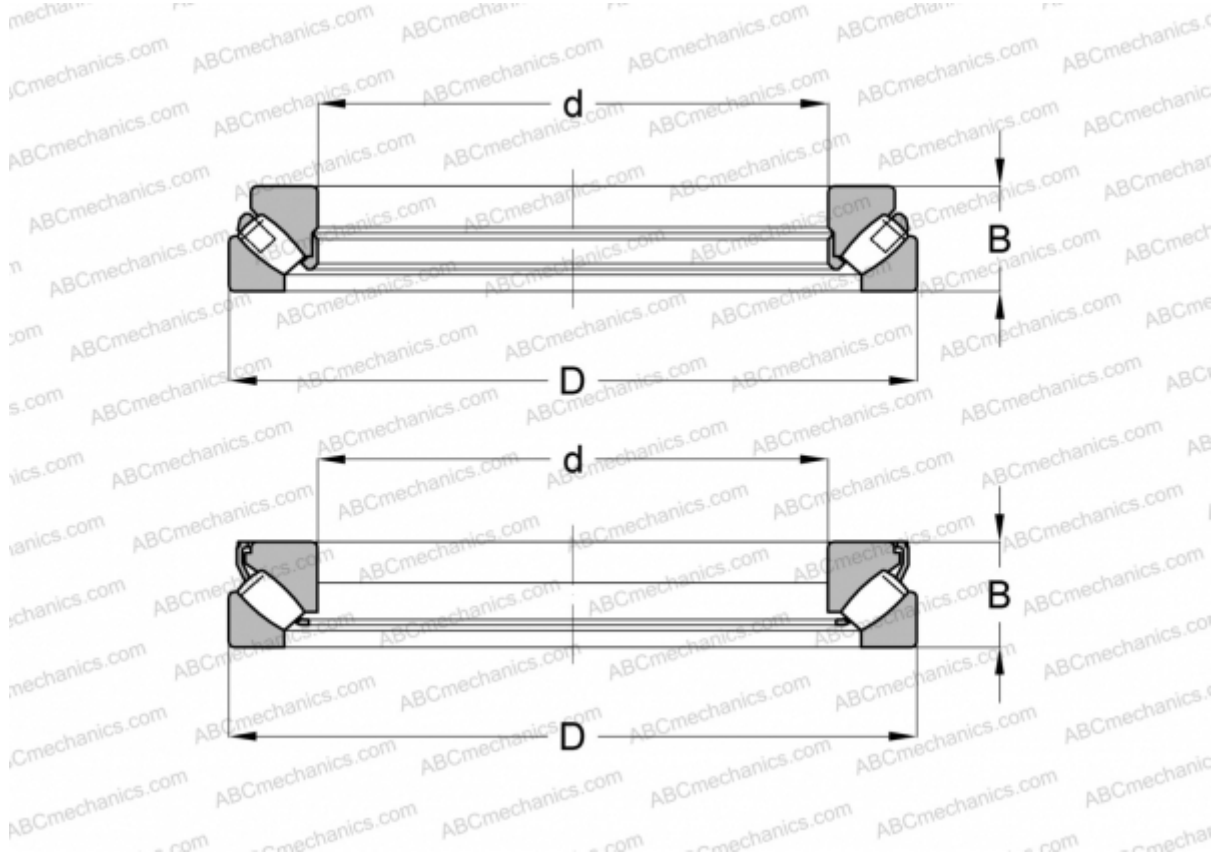

Technical specification

DIMENSIONS, MM

d	340,000
D	620,000
B	170,000

WEIGHT, KG 220,000

MANUFACTURER [SKF](#)

INTERCHANGE

ABC	29468E M
FAG	29468 E.MB
TORRINGTON	29468

CALCULATION DATA

Basic dynamic load rating, C	5750,000 kN
Basic static load rating, Co	22400,000 kN
Fatigue load limit, Pu	1760,000 kN

CALCULATION DATA

Reference speed	500 r/min
Limiting speed	1000 r/min