

29468 TORRINGTON

Spherical roller thrust bearings

TYPE: Roller bearings, Thrust roller bearing, Axial spherical

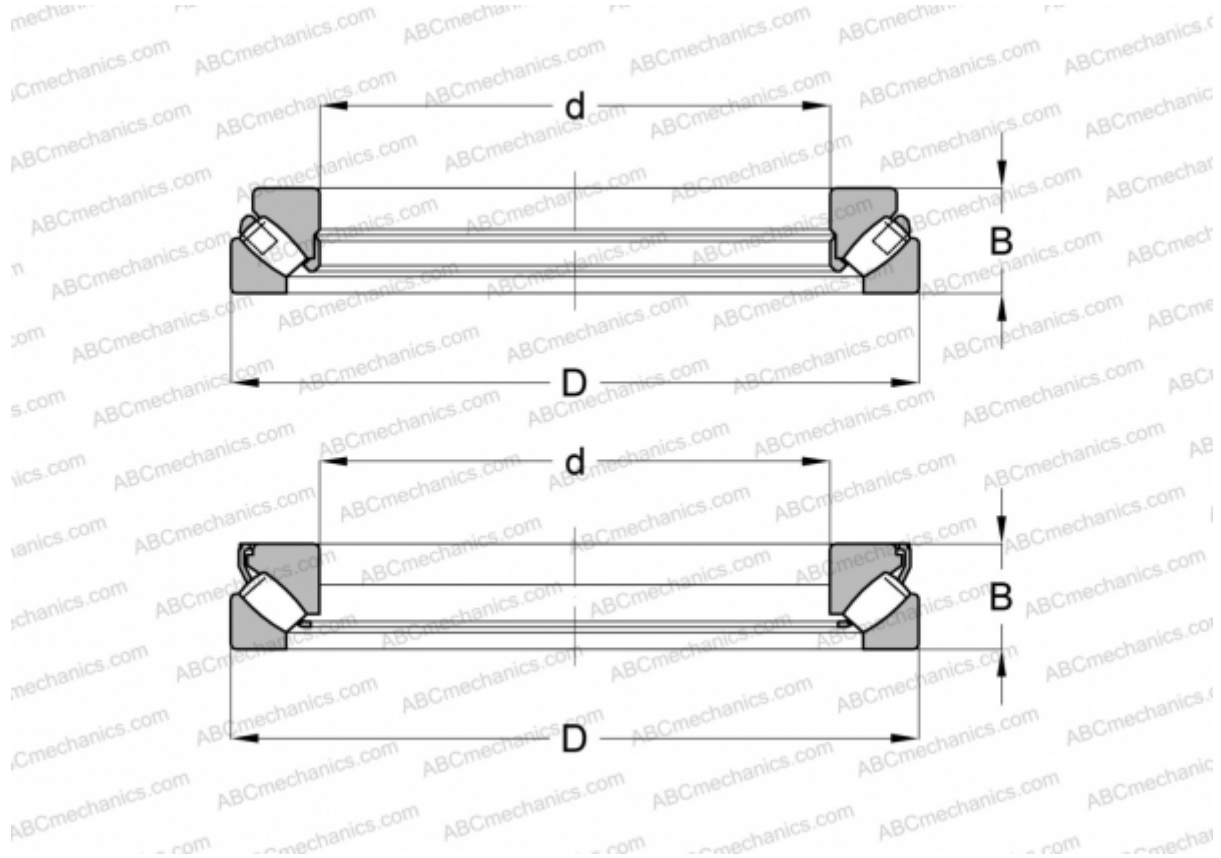

Technical specification

DIMENSIONS, MM

d	340,000
D	620,000
B	170,000

WEIGHT, KG 230,878

MANUFACTURER [TORRINGTON](#)

INTERCHANGE

ABC	29468E M
FAG	29468 E.MB
SKF	29468 E