

29272E M ABC

Spherical roller thrust bearings

TYPE: Roller bearings, Thrust roller bearing, Axial spherical

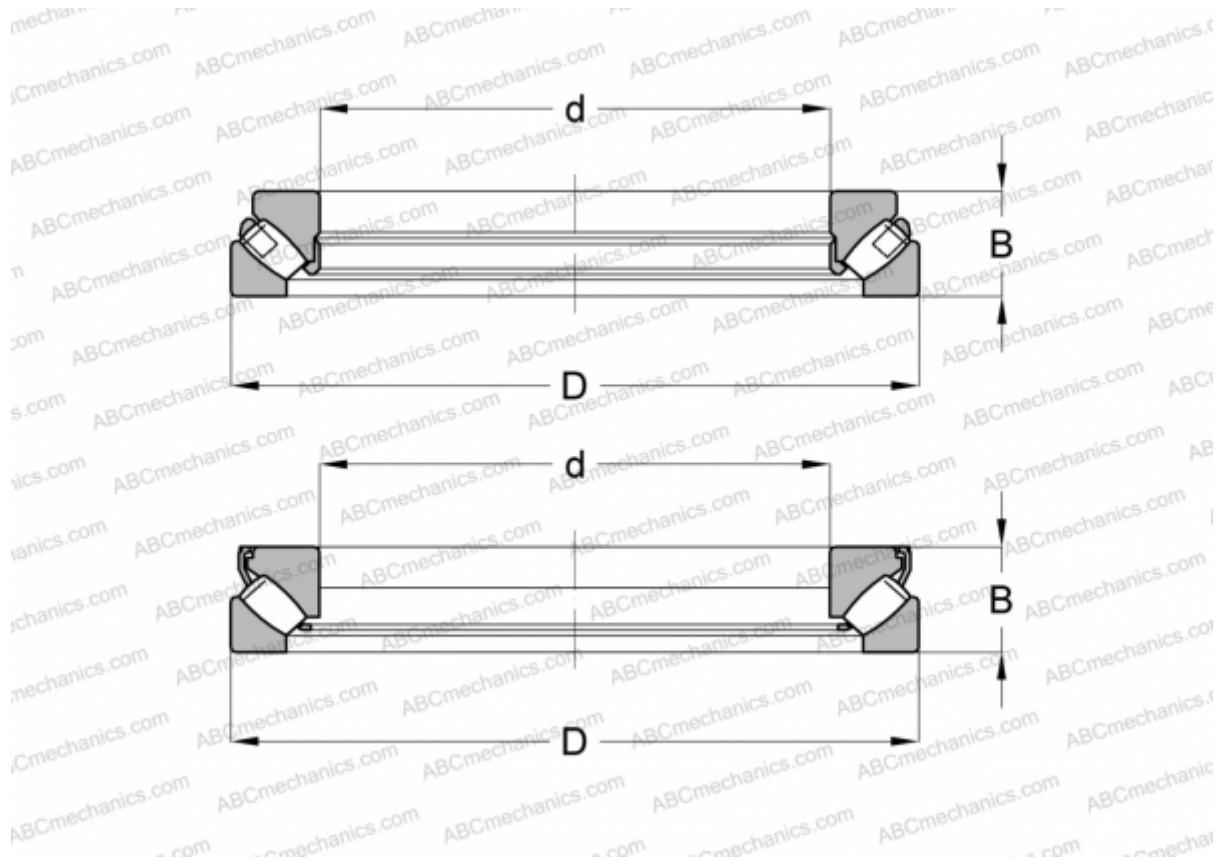

Technical specification

DIMENSIONS, MM

d	360,000
D	500,000
B	85,000

WEIGHT, KG 46,266

MANUFACTURER [ABC](#)

INTERCHANGE

FAG	29272 E.MB
SKF	29272