

29272 SKF

Spherical roller thrust bearings

TYPE: Roller bearings, Thrust roller bearing, Axial spherical

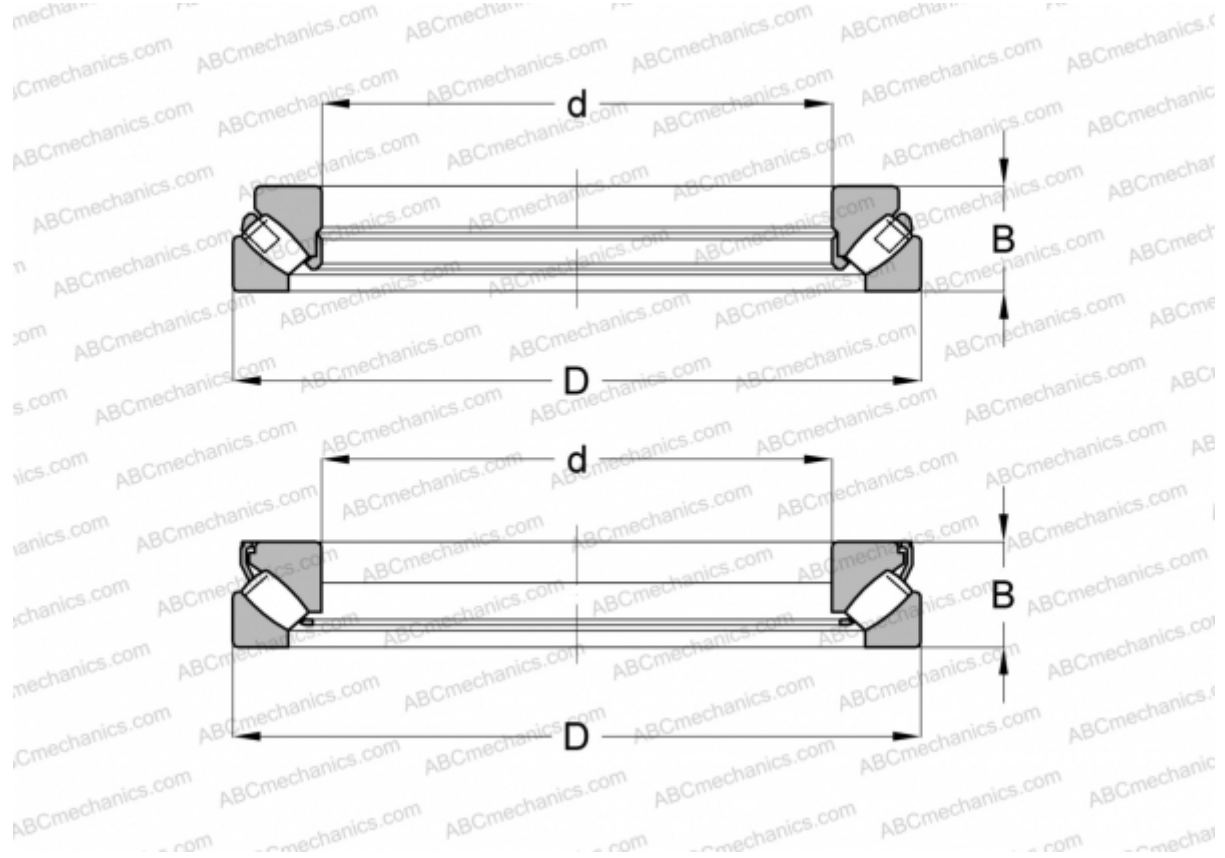

Technical specification

DIMENSIONS, MM

d	360,000
D	500,000
B	85,000

WEIGHT, KG 52,000

MANUFACTURER [SKF](#)

INTERCHANGE

ABC	29272E M
FAG	29272 E.MB

CALCULATION DATA

Basic dynamic load rating, C	1460,000 kN
Basic static load rating, Co	6800,000 kN
Fatigue load limit, Pu	585,000 kN
Reference speed	750 r/min

CALCULATION DATA

Limiting speed	1200 r/min
----------------	------------