

29276 SKF

Spherical roller thrust bearings

TYPE: Roller bearings, Thrust roller bearing, Axial spherical

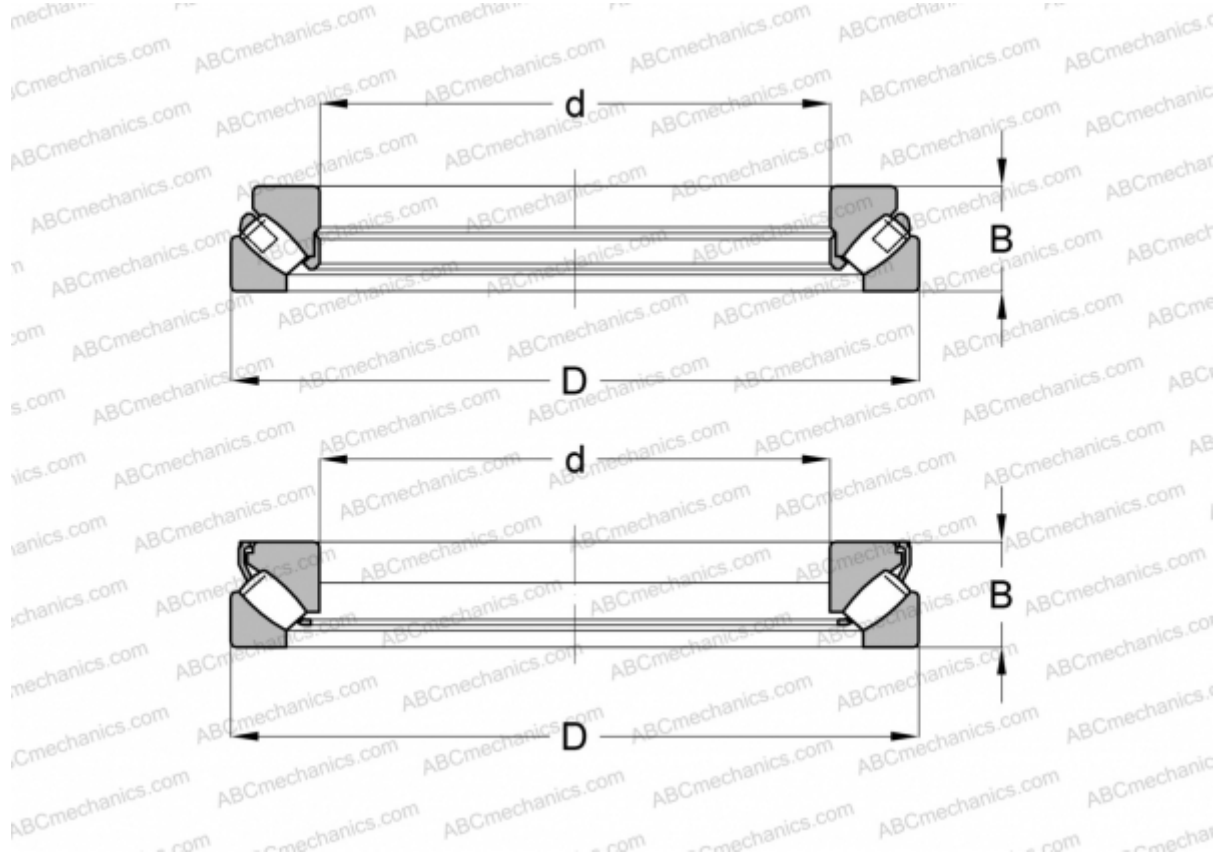

Technical specification

DIMENSIONS, MM

d	380,000
D	520,000
B	85,000

WEIGHT, KG 53,000

MANUFACTURER [SKF](#)

INTERCHANGE

ABC	29276E M
FAG	29276 E.MB

CALCULATION DATA

Basic dynamic load rating, C	1580,000 kN
Basic static load rating, Co	7650,000 kN
Fatigue load limit, Pu	655,000 kN
Reference speed	700 r/min

CALCULATION DATA

Limiting speed	1100 r/min
----------------	------------