

YAR 205-2RF SKF

Insert bearings

TYPE: Ball bearings, Radial insert bearings, Grub screw to inner ring, Spherical outer ring, Series YAR, NBR contact seal and additional rubberized flinger on both sides (SKF)

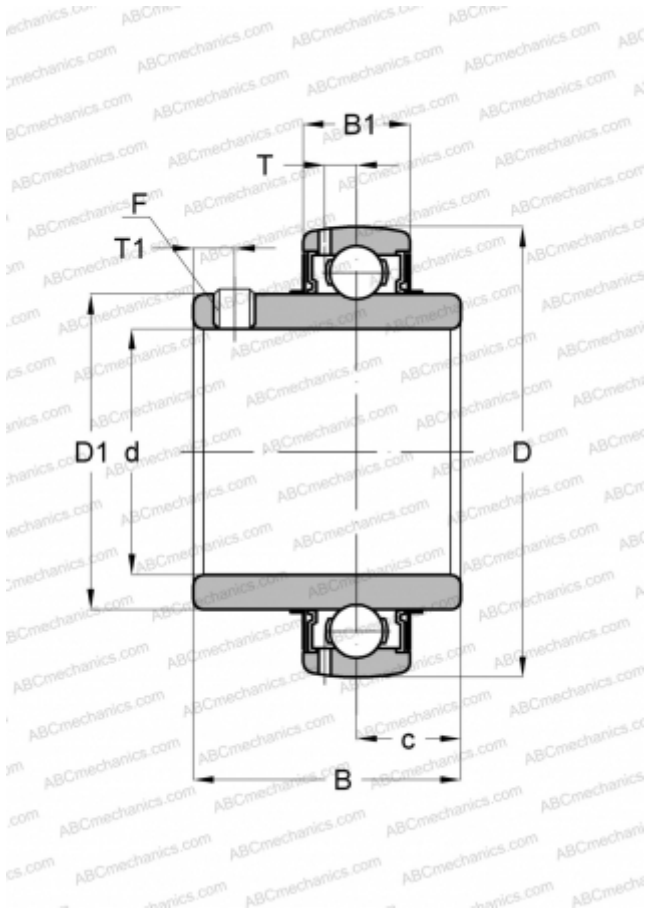

Technical specification

DIMENSIONS, MM

d	25,000
D	52,000
D1	33,700
B	34,100
C	15,000

MANUFACTURER

[SKF](#)

CALCULATION DATA

Basic dynamic load rating, C	14,000 kN
Basic static load rating, Co	7,800 kN
Fatigue load limit, Pu	0,335 kN
Limiting speed	4300 r/min