

## YAR 207-2RF SKF

Insert bearings

TYPE: Ball bearings, Radial insert bearings, Grub screw to inner ring, Spherical outer ring, Series YAR, NBR contact seal and additional rubberized flinger on both sides (SKF)

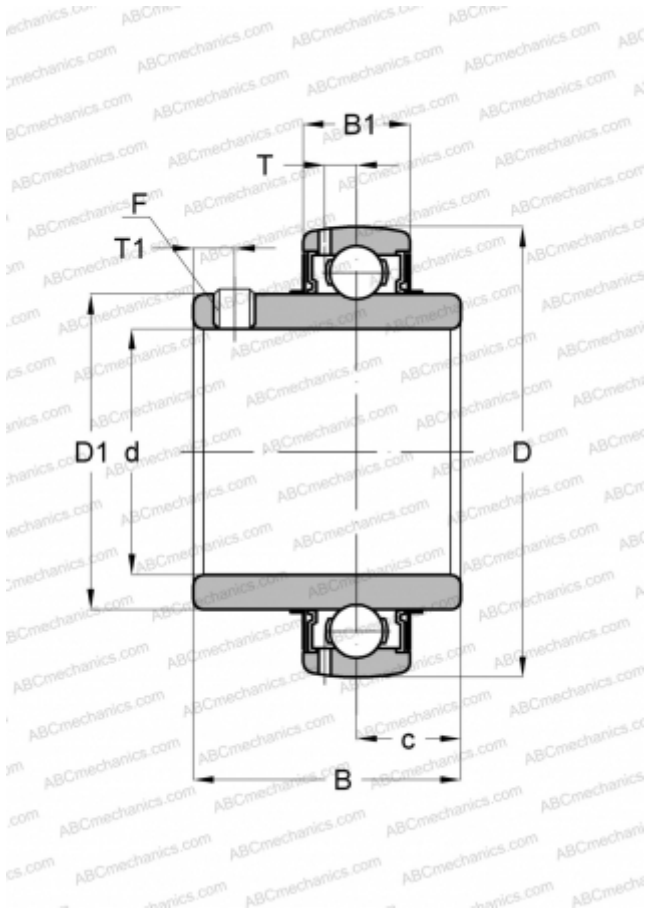

### Technical specification

#### DIMENSIONS, MM

d	35,000
D	72,000
D1	46,100
B	42,900
C	19,000

#### MANUFACTURER

[SKF](#)

#### CALCULATION DATA

Basic dynamic load rating, C	25,500 kN
Basic static load rating, Co	15,300 kN
Fatigue load limit, Pu	0,655 kN
Limiting speed	3200 r/min