

YAT 205 SKF

Insert bearings

TYPE: Ball bearings, Radial insert bearings, Grub screw to inner ring, Spherical outer ring, Series YAT (SKF)

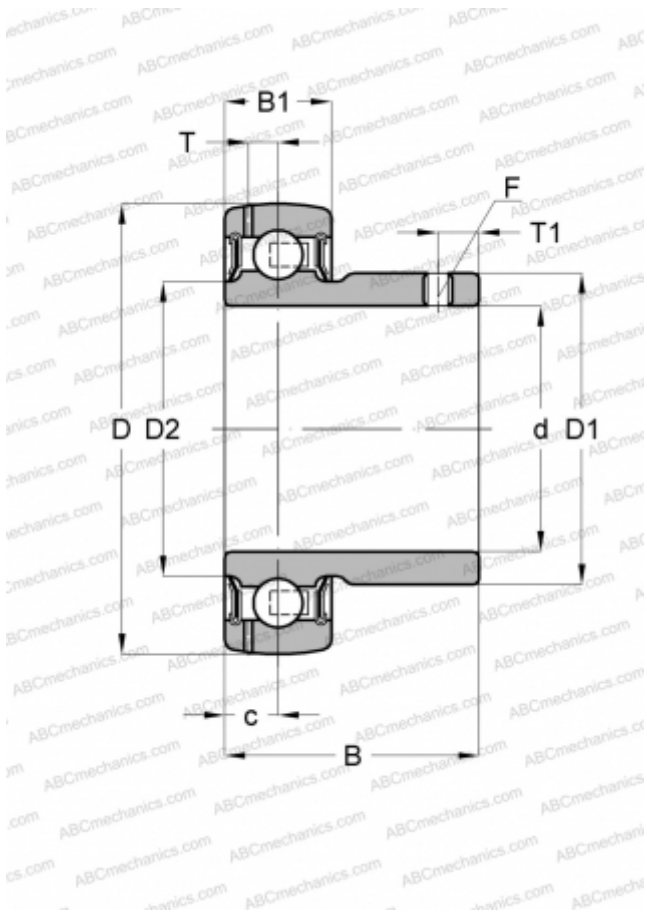

Technical specification

DIMENSIONS, MM

d	25,000
D	52,000
D1	33,700
B	27,200
B1	15,000

WEIGHT, KG

0,140

MANUFACTURER

[SKF](#)

CALCULATION DATA

Basic dynamic load rating, C	14,000 kN
Basic static load rating, Co	7,800 kN
Fatigue load limit, Pu	0,335 kN
Limiting speed	7000 r/min