

YAT 209 SKF

Insert bearings

TYPE: Ball bearings, Radial insert bearings, Grub screw to inner ring, Spherical outer ring, Series YAT (SKF)

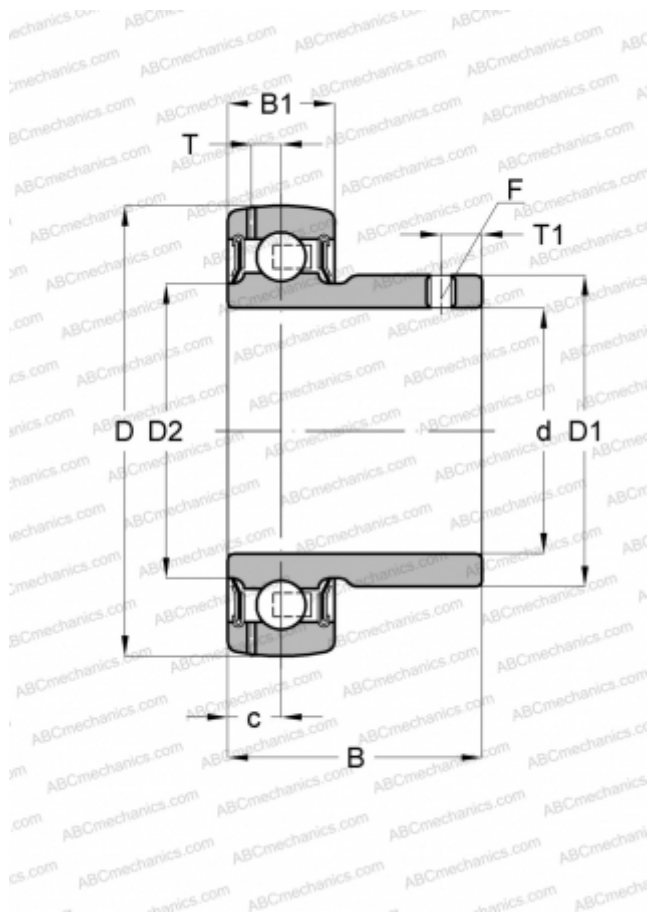

Technical specification

DIMENSIONS, MM

d	45,000
D	85,000
D1	56,800
B	37,000
B1	22,000

WEIGHT, KG

0,480

MANUFACTURER

[SKF](#)

CALCULATION DATA

Basic dynamic load rating, C	33,200 kN
Basic static load rating, Co	21,600 kN
Fatigue load limit, Pu	0,915 kN
Limiting speed	4300 r/min