

YET 207 SKF

Insert bearings

TYPE: Ball bearings, Radial insert bearings, With eccentric locking collar, Spherical outer ring, Series YET (SKF)

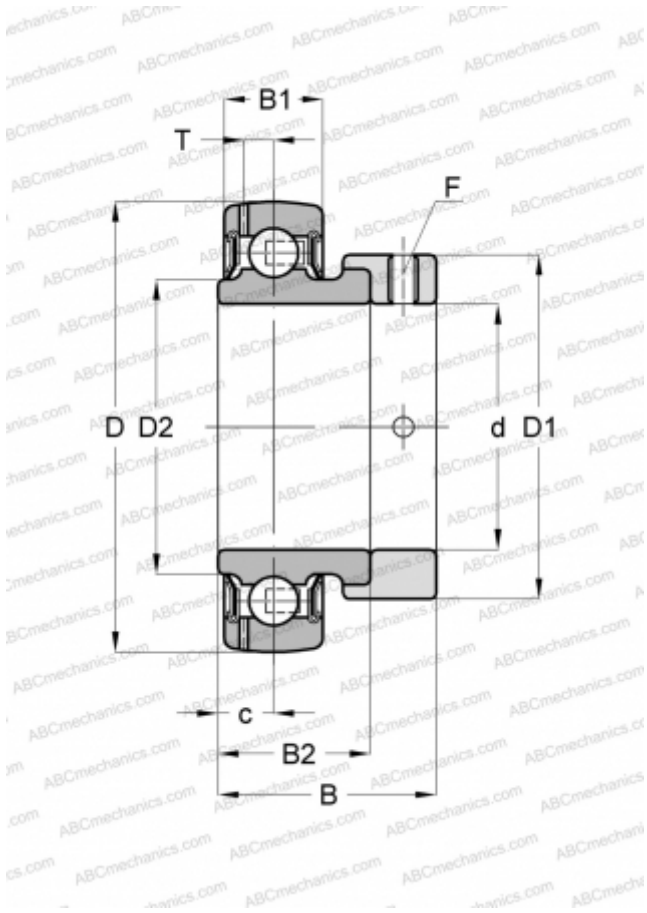

Technical specification

DIMENSIONS, MM

d	35,000
D	72,000
D1	51,100
D2	46,100
B	38,900
B1	19,000
B2	25,400

WEIGHT, KG

0,440

MANUFACTURER

[SKF](#)

CALCULATION DATA

Basic dynamic load rating, C	25,500 kN
Basic static load rating, Co	15,300 kN
Fatigue load limit, Pu	0,655 kN
Limiting speed	5300 r/min