

## E2.YET 204 SKF

Insert bearings

TYPE: Ball bearings, Radial insert bearings, With eccentric locking collar, Spherical outer ring, Series YET, Energy Efficient bearing (SKF)

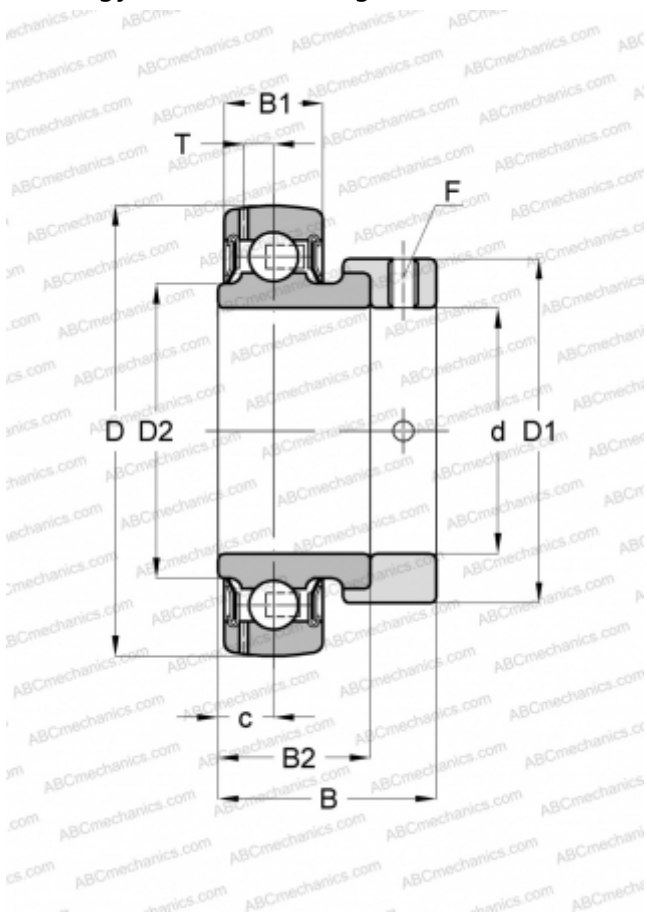

### Technical specification

#### DIMENSIONS, MM

d	20,000
D	47,000
D1	32,400
D2	28,200
B	31,000
B1	14,000
B2	21,500

#### WEIGHT, KG

0,160

#### MANUFACTURER

[SKF](#)

#### CALCULATION DATA

Basic dynamic load rating, C	12,700 kN
Basic static load rating, Co	6,550 kN
Fatigue load limit, Pu	0,280 kN
Limiting speed	8500 r/min