

E2.YET 205 SKF

Insert bearings

TYPE: Ball bearings, Radial insert bearings, With eccentric locking collar, Spherical outer ring, Series YET, Energy Efficient bearing (SKF)

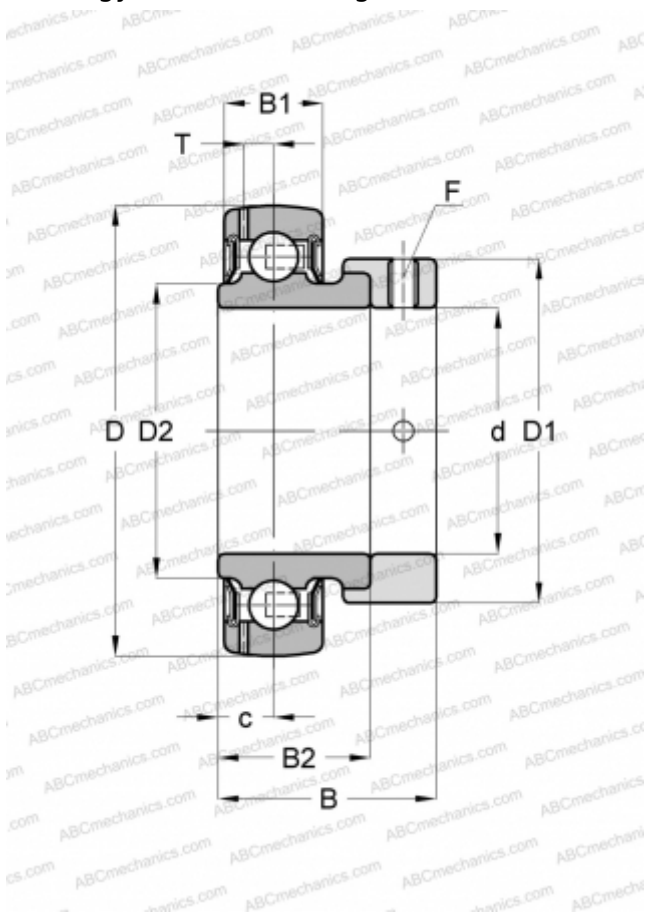

Technical specification

DIMENSIONS, MM

d	25,000
D	52,000
D1	37,400
D2	33,700
B	31,000
B1	15,000
B2	21,500

WEIGHT, KG

0,190

MANUFACTURER

[SKF](#)

CALCULATION DATA

Basic dynamic load rating, C	14,000 kN
Basic static load rating, Co	7,800 kN
Fatigue load limit, Pu	0,335 kN
Limiting speed	7000 r/min