

## YEL 208-2F SKF

Insert bearings

TYPE: Ball bearings, Radial insert bearings, With eccentric locking collar, Spherical outer ring, Series YEL (SKF)

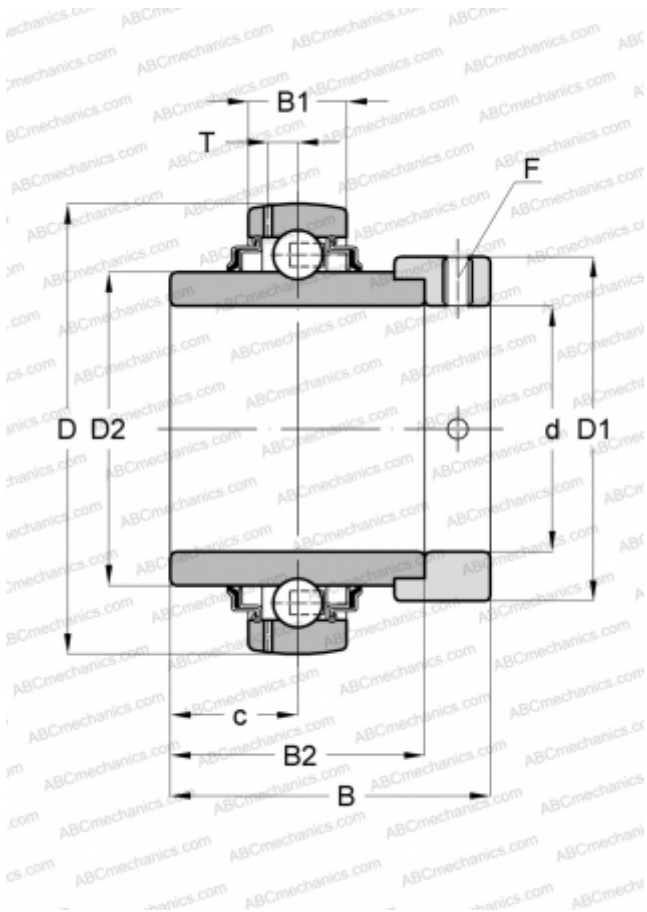

### Technical specification

#### DIMENSIONS, MM

d	40,000
D	80,000
D1	56,500
D2	51,800
B	56,300
B1	21,000
B2	42,800

#### WEIGHT, KG

0,670

#### MANUFACTURER

[SKF](#)

#### CALCULATION DATA

Basic dynamic load rating, C	30,700 kN
Basic static load rating, Co	19,000 kN
Fatigue load limit, Pu	0,800 kN
Limiting speed	4800 r/min