

## YEL 205-2RF/VL065 SKF

Insert bearings

TYPE: Ball bearings, Radial insert bearings, With eccentric locking collar, Spherical outer ring, Series YEL, zinc-coated inner ring bore and side faces (SKF)

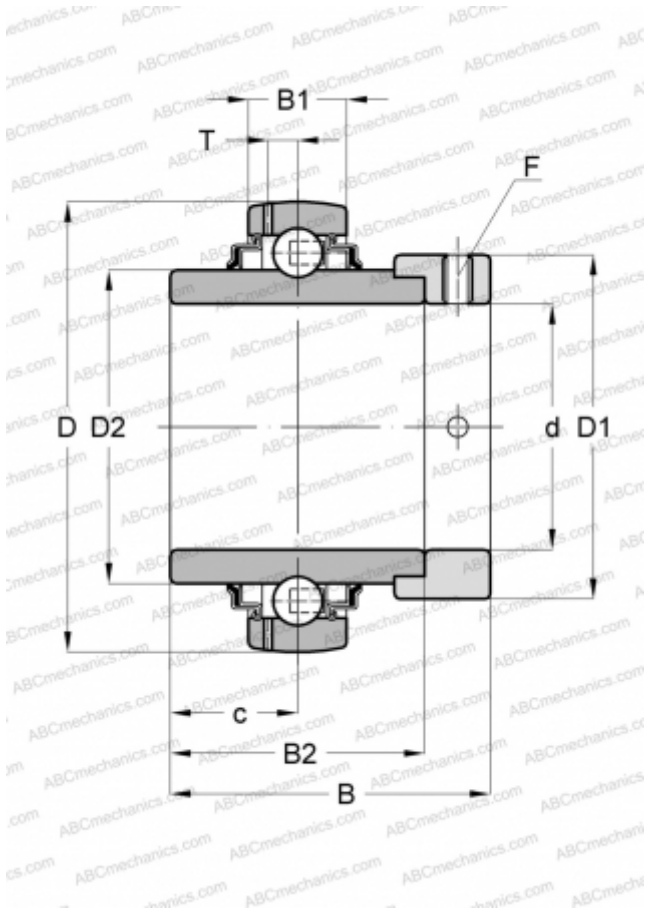

### Technical specification

#### DIMENSIONS, MM

d	25,000
D	52,000
D1	37,400
D2	33,700
B	44,400
B1	15,000
B2	34,900

#### WEIGHT, KG

0,240

#### MANUFACTURER

[SKF](#)

#### CALCULATION DATA

Basic dynamic load rating, C	14,000 kN
Basic static load rating, Co	7,800 kN
Fatigue load limit, Pu	0,335 kN
Limiting speed	4300 r/min