

YELAG 210 SKF

Insert bearings

TYPE: Ball bearings, Radial insert bearings, With eccentric locking collar, Spherical outer ring, Series YELAG, for agricultural applications (SKF)

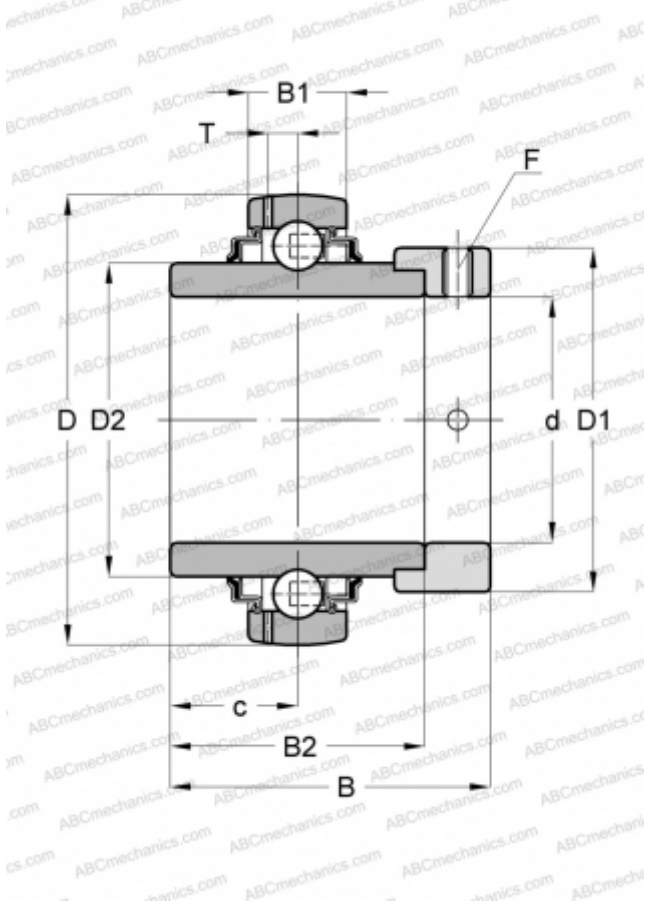

Technical specification

DIMENSIONS, MM

d	50,000
D	90,000
D1	67,200
D2	62,500
B	62,700
B1	22,000
B2	49,200

WEIGHT, KG

0,870

MANUFACTURER

[SKF](#)

CALCULATION DATA

Basic dynamic load rating, C	35,100 kN
Basic static load rating, Co	23,200 kN
Fatigue load limit, Pu	0,980 kN
Limiting speed	800 r/min