

YET 209-111 SKF

Insert bearings

TYPE: Ball bearings, Radial insert bearings, With eccentric locking collar, Spherical outer ring, Series YET, inch (SKF)

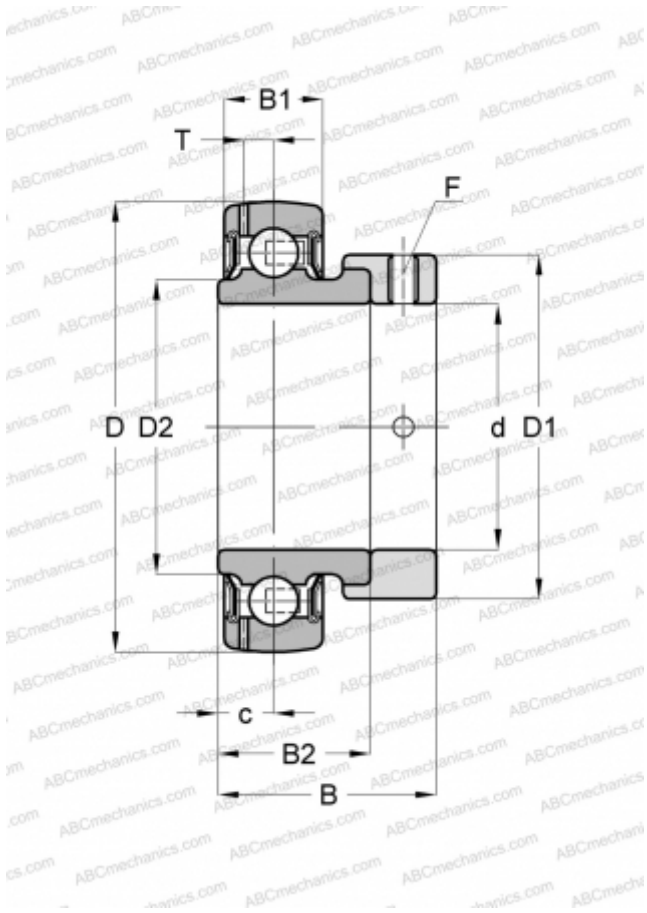

Technical specification

DIMENSIONS, MM

d	42,863
D	85,000
D1	62,000
D2	56,800
B	43,700
B1	22,000
B2	30,200

WEIGHT, KG

0,740

MANUFACTURER

[SKF](#)

CALCULATION DATA

Basic dynamic load rating, C	33,200 kN
Basic static load rating, Co	21,600 kN
Fatigue load limit, Pu	0,915 kN
Limiting speed	4300 r/min