

YELAG 209-112 SKF

Insert bearings

TYPE: Ball bearings, Radial insert bearings, With eccentric locking collar, Spherical outer ring, Series YELAG, for agricultural applications, inch (SKF)

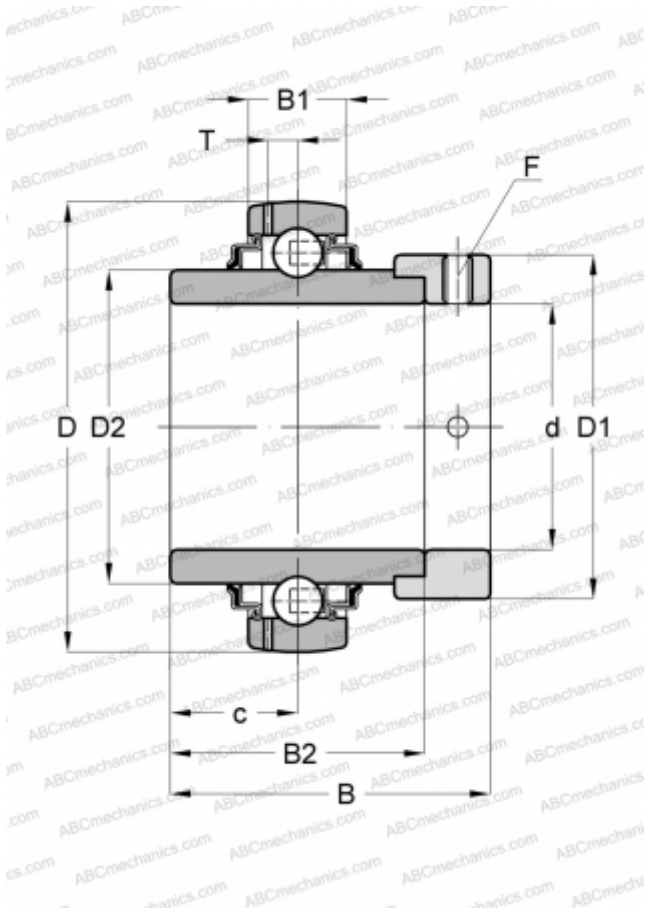

Technical specification

DIMENSIONS, MM

d	44,450
D	85,000
D1	62,000
D2	56,800
B	56,300
B1	22,000
B2	42,800

WEIGHT, KG

0,790

MANUFACTURER

[SKF](https://www.skf.com)

CALCULATION DATA

Basic dynamic load rating, C	33,200 kN
Basic static load rating, Co	21,600 kN
Fatigue load limit, Pu	0,915 kN
Limiting speed	850 r/min