

YSP 206 SB-2F SKF

Insert bearings

TYPE: Ball bearings, Radial insert bearings, Location by SKF ConCentra, Spherical outer ring, Series YSP (SKF)

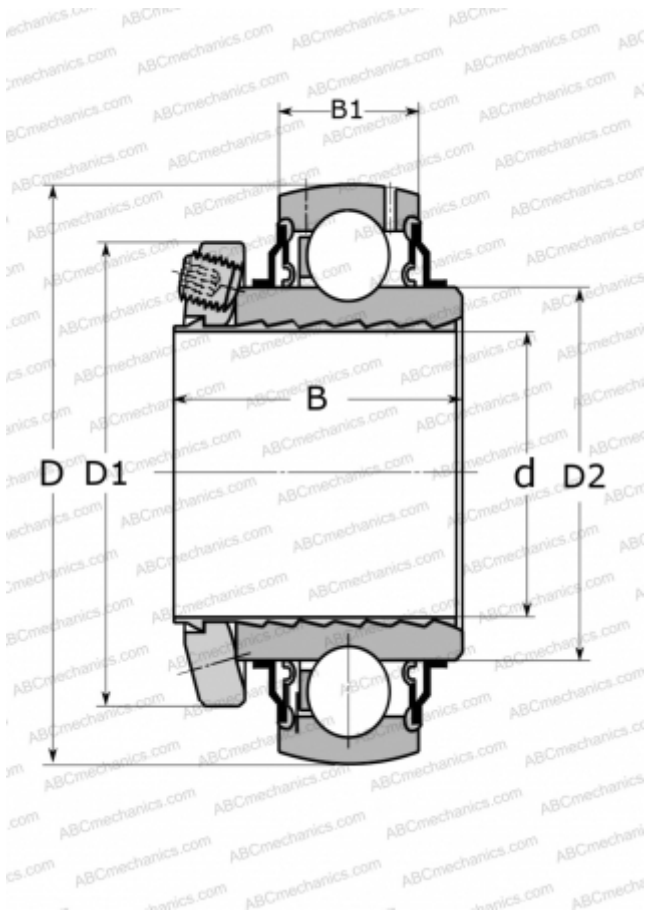

Technical specification

DIMENSIONS, MM

d	30,000
D	62,000
D1	48,000
D2	39,700
B	37,000
B1	18,000

MANUFACTURER

[SKF](#)

CALCULATION DATA

Basic dynamic load rating, C	19,500 kN
Basic static load rating, Co	11,200 kN
Fatigue load limit, Pu	0,475 kN
Limiting speed	6300 r/min