

YSP 209 SB-2F SKF

Insert bearings

TYPE: Ball bearings, Radial insert bearings, Location by SKF ConCentra, Spherical outer ring, Series YSP (SKF)

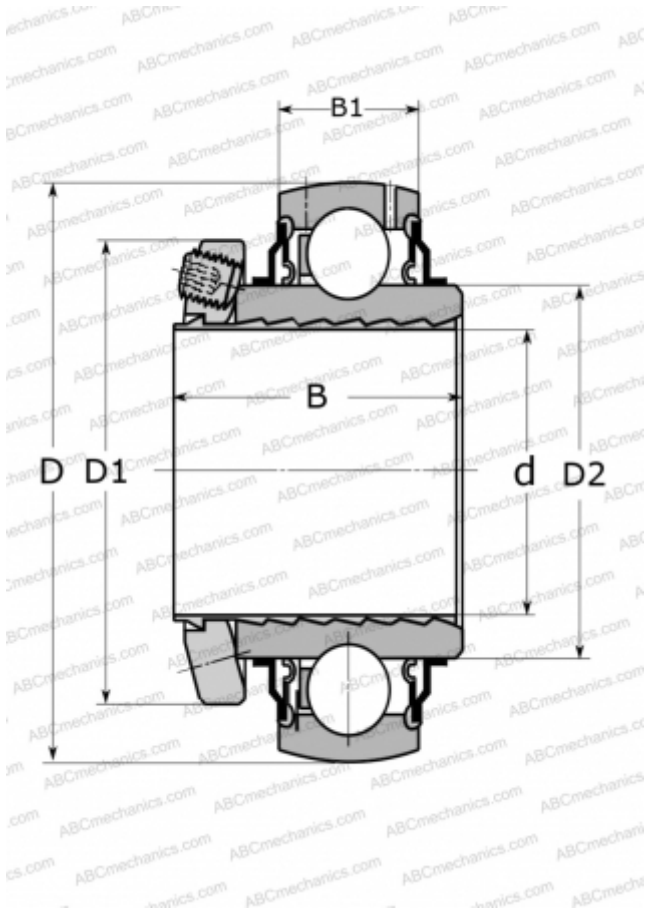

Technical specification

DIMENSIONS, MM

d	45,000
D	85,000
D1	67,000
D2	56,800
B	44,000
B1	22,000

MANUFACTURER

[SKF](#)

CALCULATION DATA

Basic dynamic load rating, C	33,200 kN
Basic static load rating, Co	21,600 kN
Fatigue load limit, Pu	0,915 kN
Limiting speed	4300 r/min