

## YSP 210 SB-2F SKF

Insert bearings

TYPE: Ball bearings, Radial insert bearings, Location by SKF ConCentra, Spherical outer ring, Series YSP (SKF)

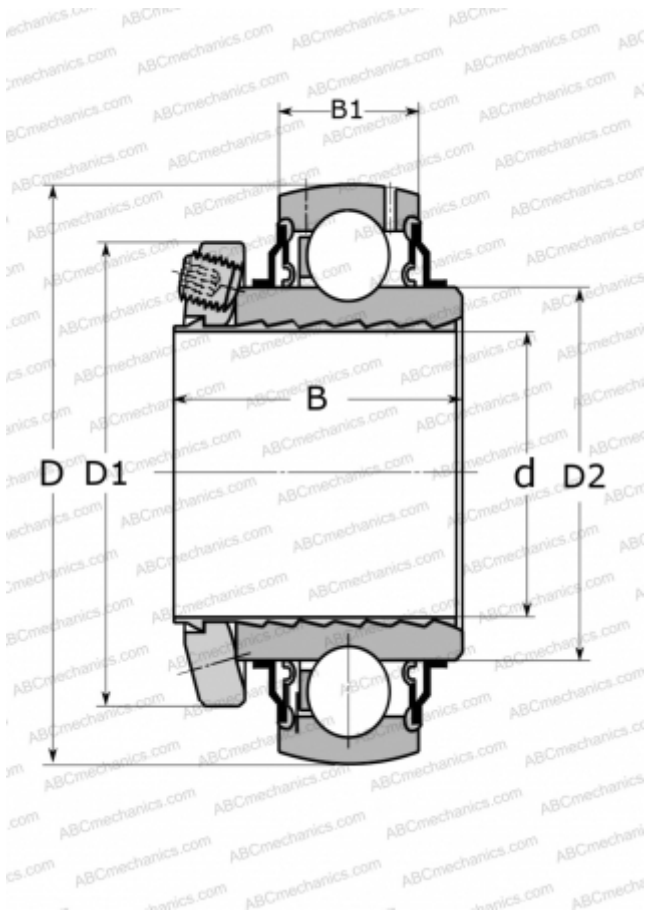

### Technical specification

#### DIMENSIONS, MM

d	50,000
D	90,000
D1	72,000
D2	62,500
B	46,000
B1	22,000

#### MANUFACTURER

[SKF](#)

#### CALCULATION DATA

Basic dynamic load rating, C	35,100 kN
Basic static load rating, Co	23,200 kN
Fatigue load limit, Pu	0,980 kN
Limiting speed	4000 r/min