

YSPAG 205 SKF

Insert bearings

TYPE: Ball bearings, Radial insert bearings, Location by SKF ConCentra, Spherical outer ring, Series YSPAG, for agricultural applications (SKF)

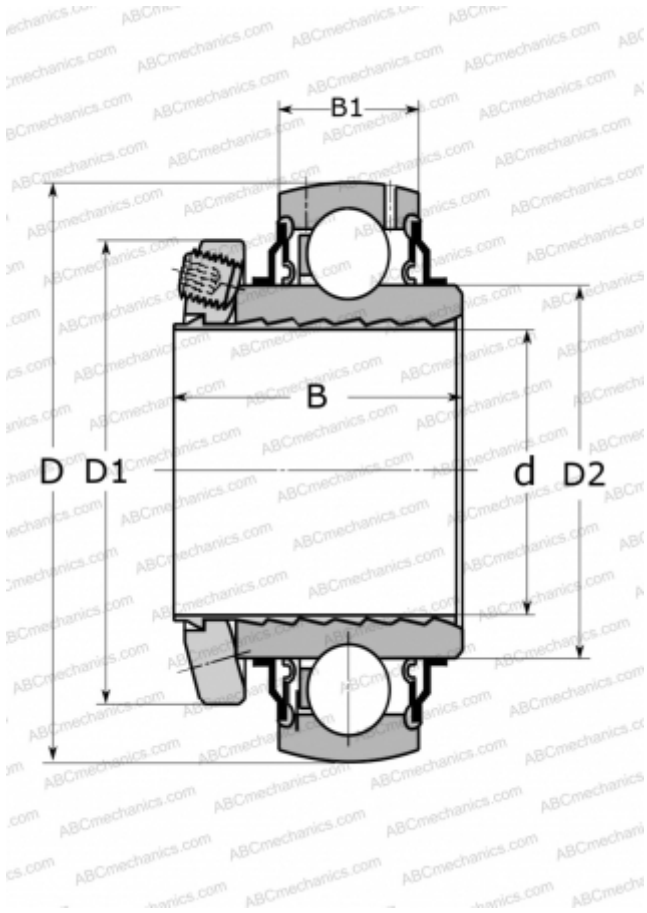

Technical specification

DIMENSIONS, MM

d	25,000
D	52,000
D1	41,700
D2	33,700
B	33,000
B1	15,000

WEIGHT, KG

0,190

MANUFACTURER

[SKF](#)

CALCULATION DATA

Basic dynamic load rating, C	14,000 kN
Basic static load rating, Co	7,800 kN
Fatigue load limit, Pu	0,335 kN
Limiting speed	1500 r/min