

YSPAG 208 SKF

Insert bearings

TYPE: Ball bearings, Radial insert bearings, Location by SKF ConCentra, Spherical outer ring, Series YSPAG, for agricultural applications (SKF)

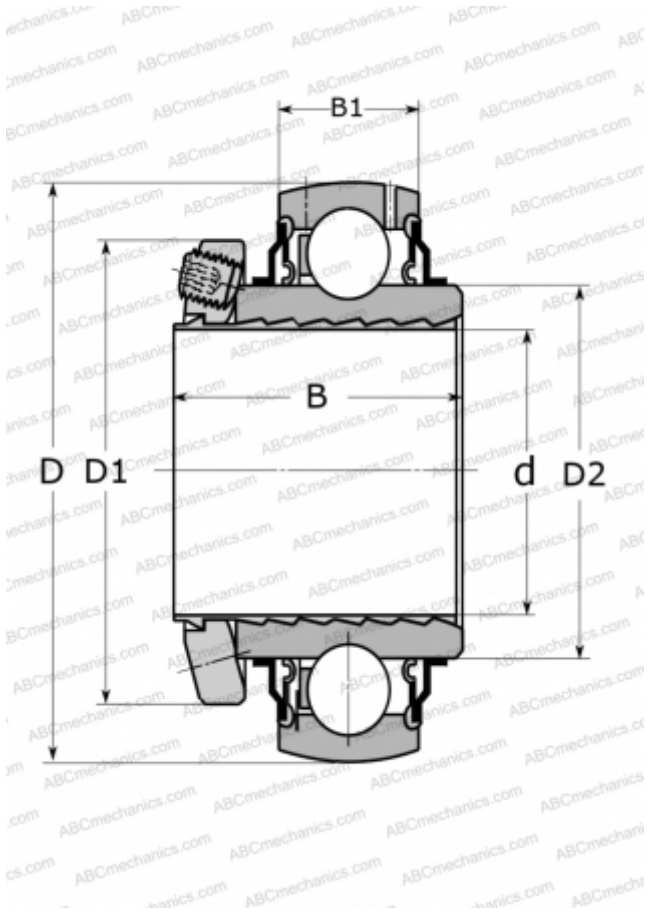

Technical specification

DIMENSIONS, MM

d	40,000
D	80,000
D1	62,000
D2	51,800
B	42,900
B1	21,000

WEIGHT, KG

0,590

MANUFACTURER

[SKF](#)

CALCULATION DATA

Basic dynamic load rating, C	30,700 kN
Basic static load rating, Co	19,000 kN
Fatigue load limit, Pu	0,800 kN
Limiting speed	950 r/min