

YSPAG 209 SKF

Insert bearings

TYPE: Ball bearings, Radial insert bearings, Location by SKF ConCentra, Spherical outer ring, Series YSPAG, for agricultural applications (SKF)

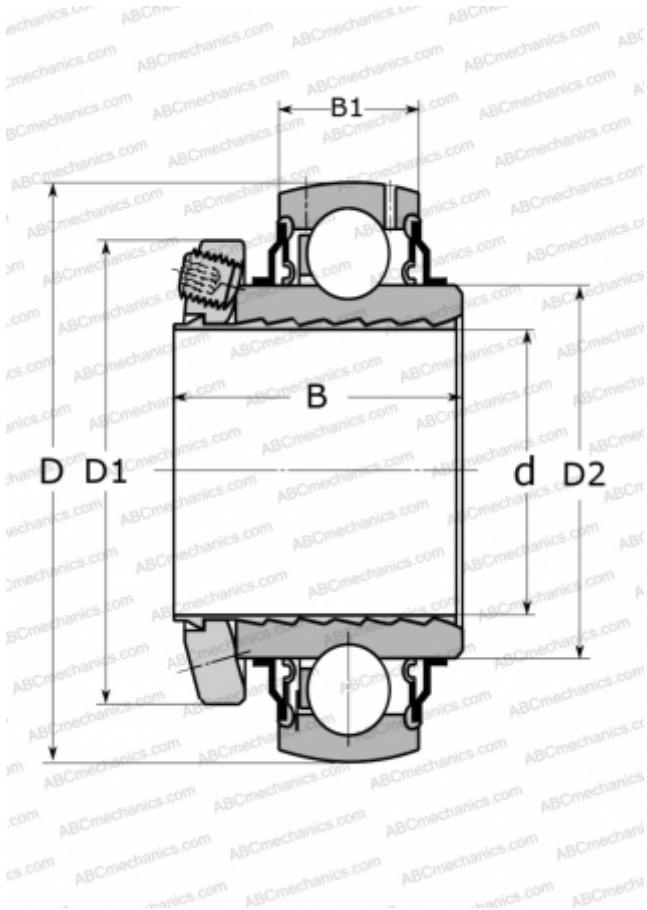

Technical specification

DIMENSIONS, MM

d	45,000
D	85,000
$D1$	67,000
$D2$	56,800
B	44,000
$B1$	22,000

WEIGHT, KG

0,640

MANUFACTURER

[SKF](#)

CALCULATION DATA

Basic dynamic load rating, C	33,200 kN
Basic static load rating, C_0	21,600 kN
Fatigue load limit, P_u	0,915 kN
Limiting speed	850 r/min