

YSP 207-106 SB-2F SKF

Insert bearings

TYPE: Ball bearings, Radial insert bearings, Location by SKF ConCentra, Spherical outer ring, Series YSP, inch (SKF)

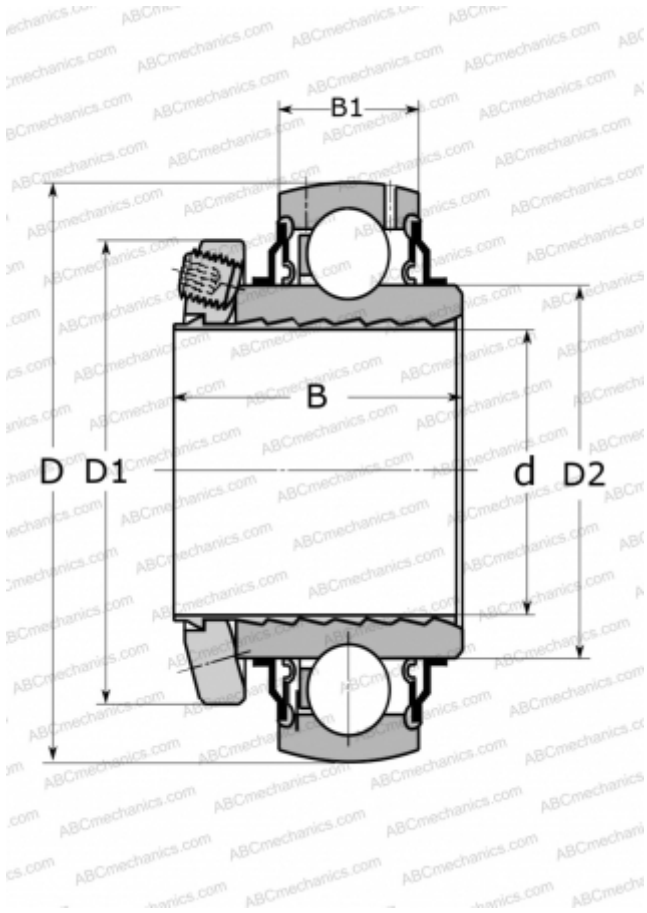

Technical specification

DIMENSIONS, MM

d	34,925
D	72,000
D1	57,000
D2	46,100
B	39,500
B1	19,000

WEIGHT, KG

0,440

MANUFACTURER

[SKF](#)

CALCULATION DATA

Basic dynamic load rating, C	25,500 kN
Basic static load rating, Co	15,300 kN
Fatigue load limit, Pu	0,655 kN
Limiting speed	5300 r/min