

YSP 211-203 SB-2F SKF

Insert bearings

TYPE: Ball bearings, Radial insert bearings, Location by SKF ConCentra, Spherical outer ring, Series YSP, inch (SKF)

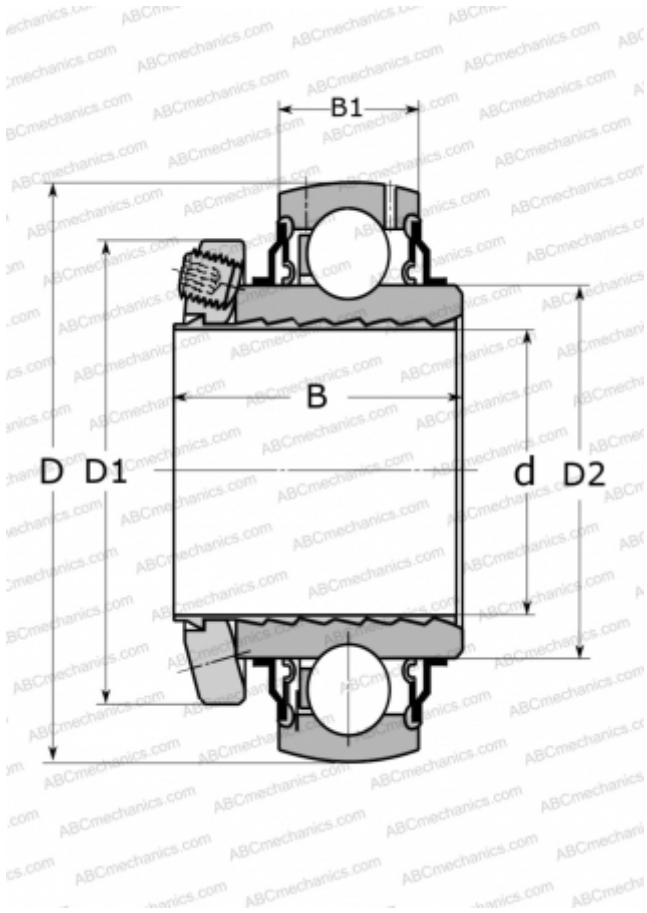

Technical specification

DIMENSIONS, MM

d	55,563
D	100,000
D1	77,600
D2	69,000
B	49,000
B1	25,000

WEIGHT, KG

0,970

MANUFACTURER

[SKF](#)

CALCULATION DATA

Basic dynamic load rating, C	43,600 kN
Basic static load rating, Co	29,000 kN
Fatigue load limit, Pu	1,250 kN
Limiting speed	3600 r/min