

E2.YSP 208-108 SB-2F SKF

Insert bearings

TYPE: Ball bearings, Radial insert bearings, Location by SKF ConCentra, Spherical outer ring, Series YSP, Energy Efficient bearing, inch (SKF)

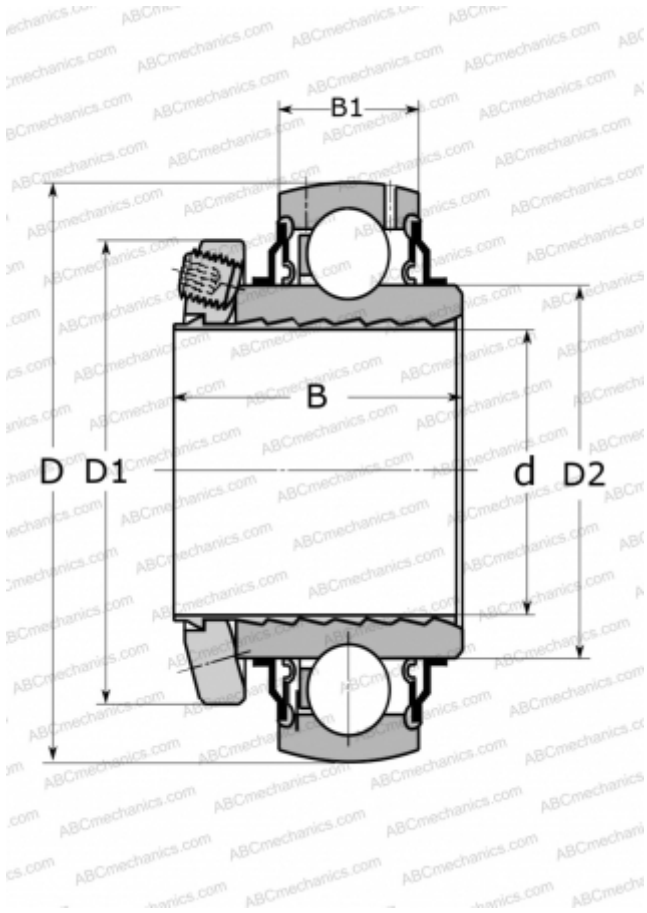

Technical specification

DIMENSIONS, MM

d	38,100
D	80,000
D1	62,000
D2	51,800
B	42,900
B1	21,000

WEIGHT, KG

0,580

MANUFACTURER

[SKF](#)

CALCULATION DATA

Basic dynamic load rating, C	30,700 kN
Basic static load rating, Co	19,000 kN
Fatigue load limit, Pu	0,800 kN
Limiting speed	4800 r/min