

YSA 206-2FK SKF

Insert bearings

TYPE: Ball bearings, Radial insert bearings, With adapter sleeve, Spherical outer ring, Series YSA (SKF)

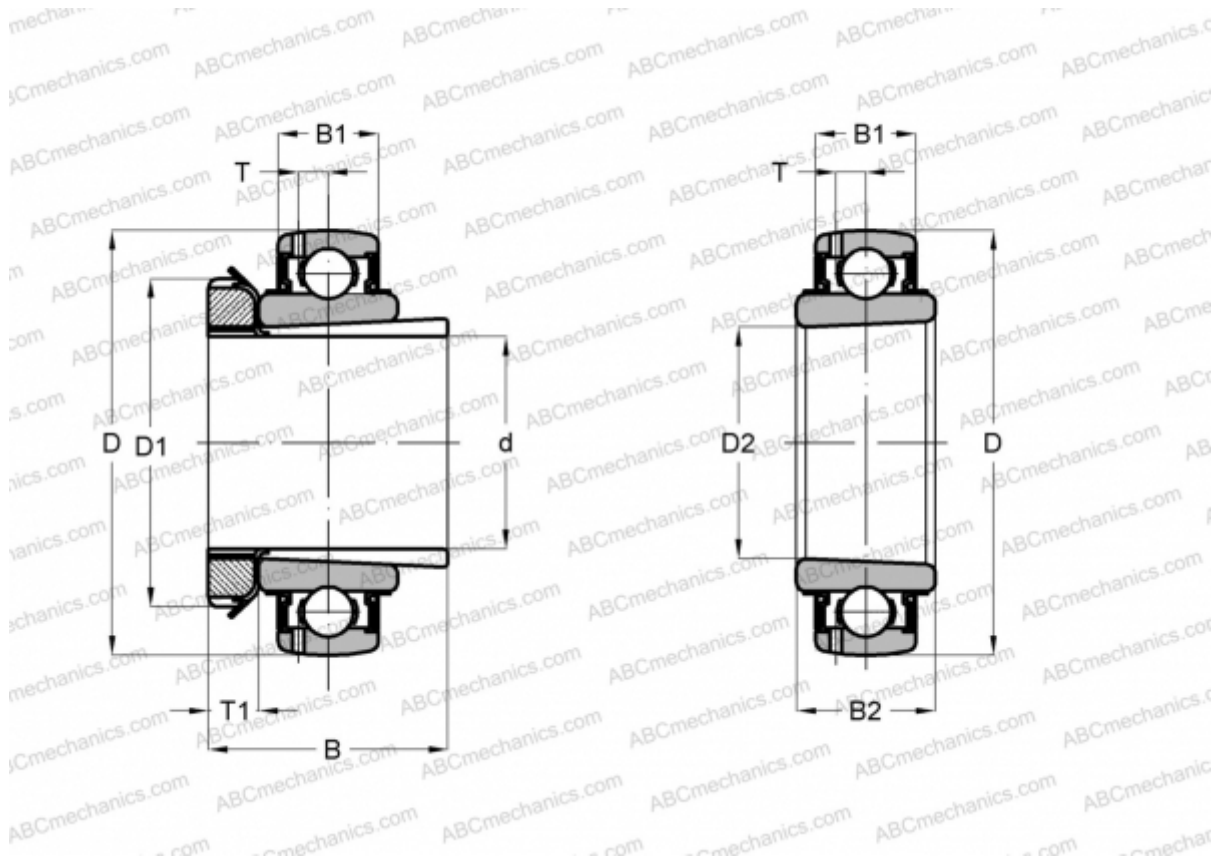

Technical specification

DIMENSIONS, MM

d	25,000
D	62,000
D1	45,000
B	38,000
B1	18,000
B2	28,000

WEIGHT, KG 0,330

MANUFACTURER [SKF](#)

CALCULATION DATA

Basic dynamic load rating, C	19,500 kN
Basic static load rating, Co	11,200 kN
Fatigue load limit, Pu	0,475 kN
Limiting speed	6300 r/min

ASSOCIATED PRODUCTS

H 2306