

YSA 209-2FK SKF

Insert bearings

TYPE: Ball bearings, Radial insert bearings, With adapter sleeve, Spherical outer ring, Series YSA (SKF)

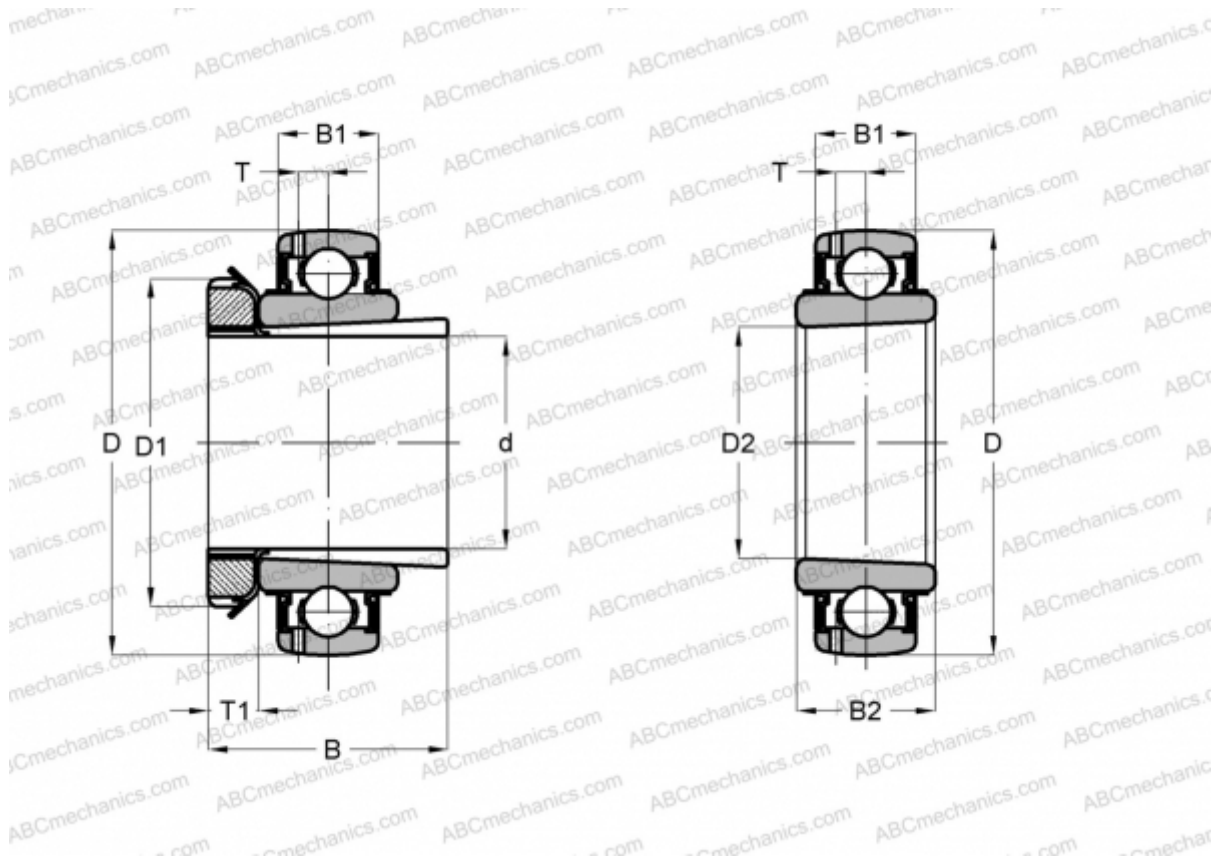

Technical specification

DIMENSIONS, MM

d	40,000
D	85,000
D1	65,000
B	50,000
B1	22,000
B2	35,000

WEIGHT, KG 0,770

MANUFACTURER [SKF](#)

CALCULATION DATA

Basic dynamic load rating, C	33,200 kN
Basic static load rating, Co	21,600 kN
Fatigue load limit, Pu	0,915 kN
Limiting speed	4300 r/min

ASSOCIATED PRODUCTS

H 2309