

YSA 213-2FK SKF

Insert bearings

TYPE: Ball bearings, Radial insert bearings, With adapter sleeve, Spherical outer ring, Series YSA (SKF)

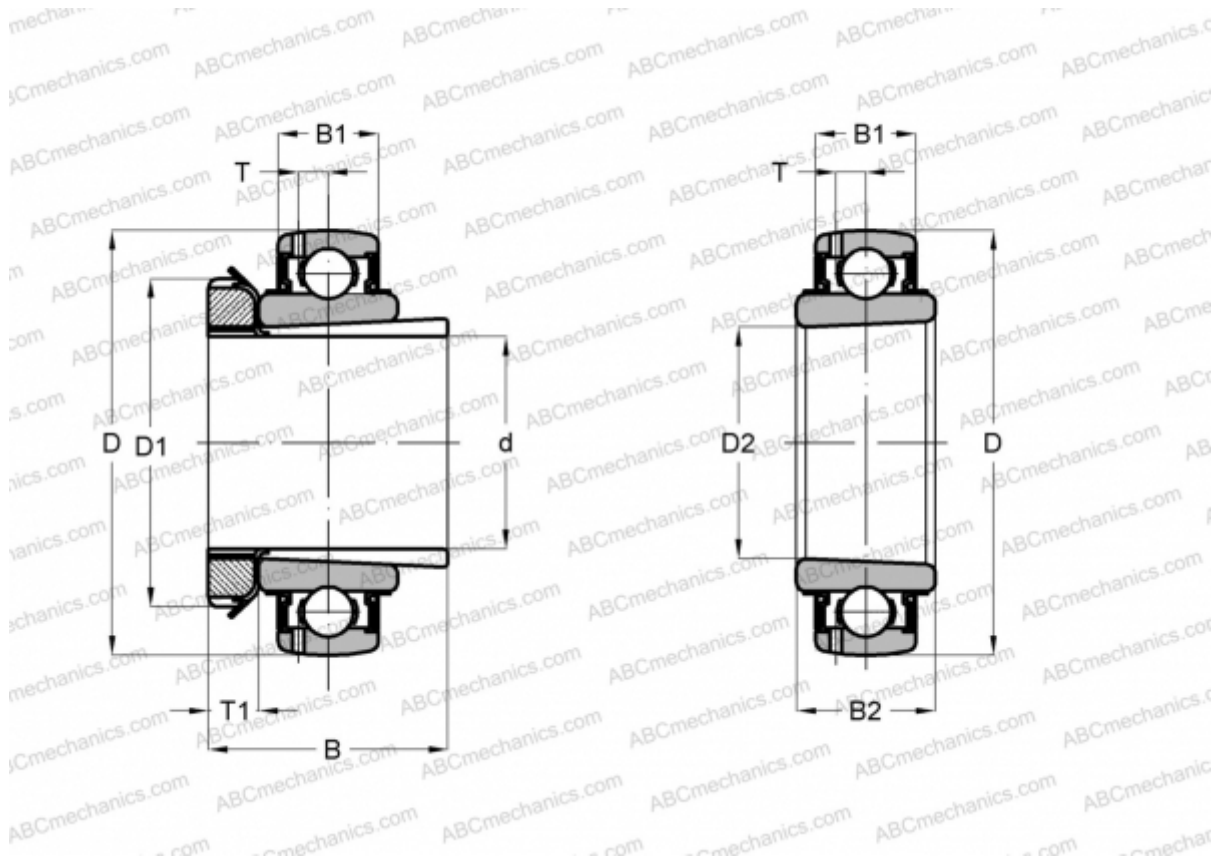

Technical specification

DIMENSIONS, MM

d	60,000
D	120,000
D1	85,000
B	65,000
B1	27,000
B2	43,500

WEIGHT, KG 1,700

MANUFACTURER [SKF](#)

CALCULATION DATA

Basic dynamic load rating, C	57,200 kN
Basic static load rating, Co	40,000 kN
Fatigue load limit, Pu	1,700 kN
Limiting speed	3000 r/min

ASSOCIATED PRODUCTS

H 2313