

YSA 205-2FK SKF

Insert bearings

TYPE: Ball bearings, Radial insert bearings, With adapter sleeve, Spherical outer ring, Series YSA, inch (SKF)

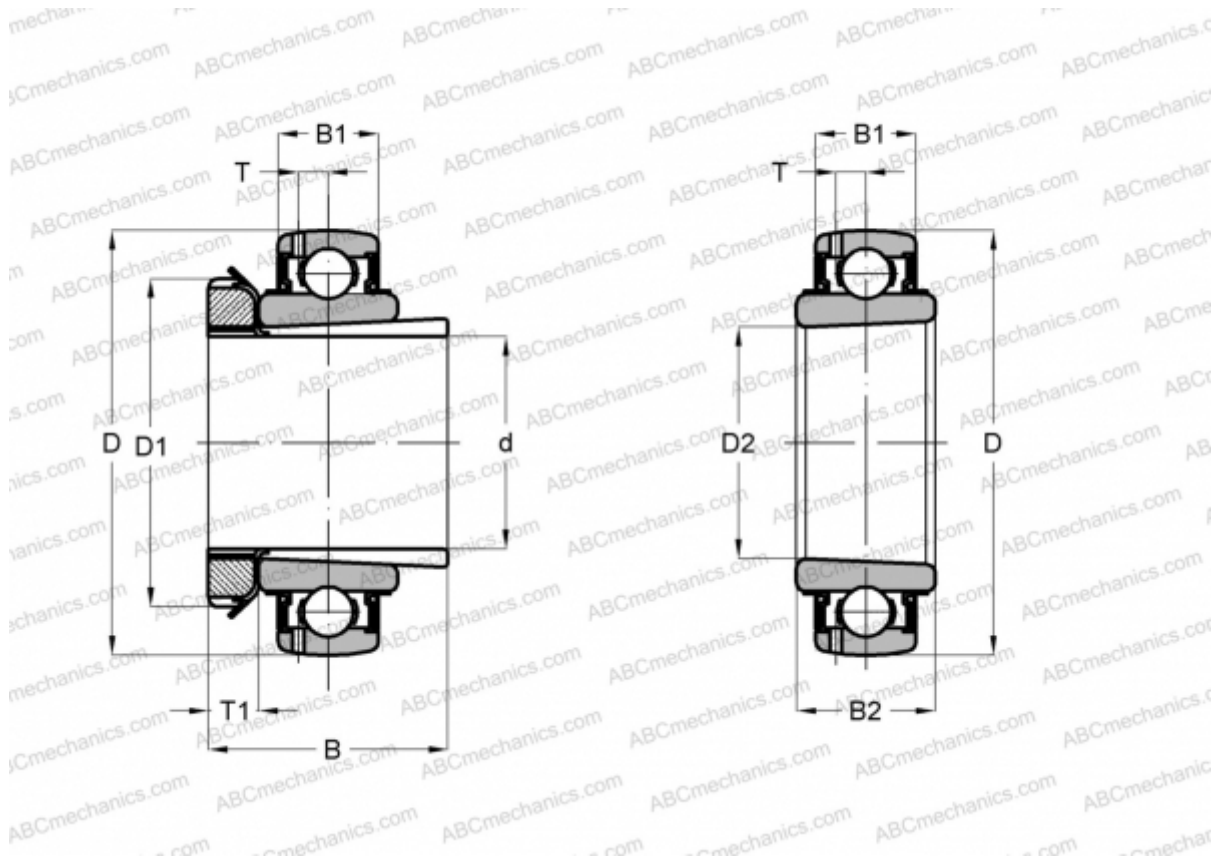

Technical specification

DIMENSIONS, MM

d	19,050
D	52,000
D1	38,000
B	35,000
B1	15,000
B2	24,000

WEIGHT, KG 0,220

MANUFACTURER [SKF](#)

CALCULATION DATA

Basic dynamic load rating, C	14,000 kN
Basic static load rating, Co	7,800 kN
Fatigue load limit, Pu	0,335 kN
Limiting speed	7000 r/min

ASSOCIATED PRODUCTS

HE 2305