

YSA 208-2FK SKF

Insert bearings

TYPE: Ball bearings, Radial insert bearings, With adapter sleeve, Spherical outer ring, Series YSA, inch (SKF)

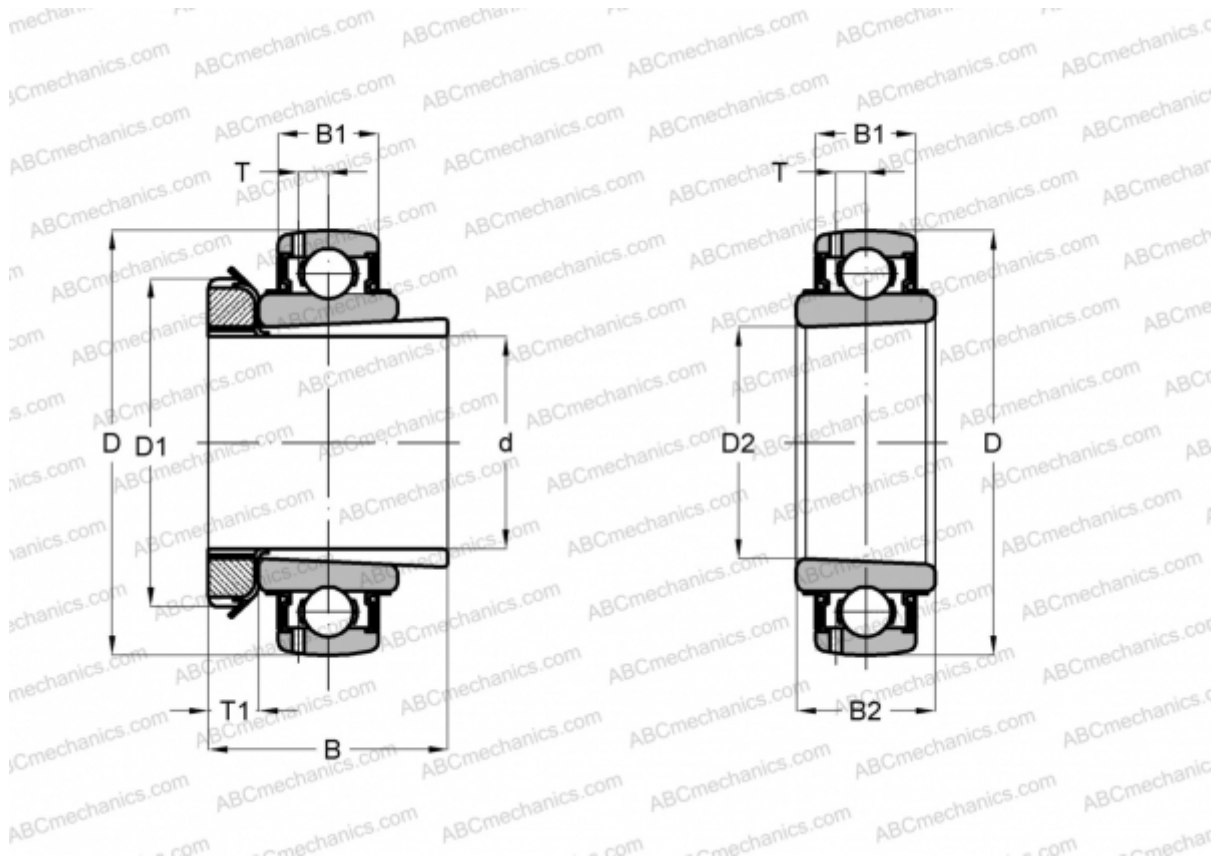

Technical specification

DIMENSIONS, MM

d	31,750
D	80,000
D1	58,000
B	46,000
B1	21,000
B2	33,900

WEIGHT, KG 0,690

MANUFACTURER [SKF](#)

CALCULATION DATA

Basic dynamic load rating, C	30,700 kN
Basic static load rating, Co	19,000 kN
Fatigue load limit, Pu	0,800 kN
Limiting speed	4800 r/min

ASSOCIATED PRODUCTS

HE 2308