

YSA 210-2FK SKF

Insert bearings

TYPE: Ball bearings, Radial insert bearings, With adapter sleeve, Spherical outer ring, Series YSA, inch (SKF)

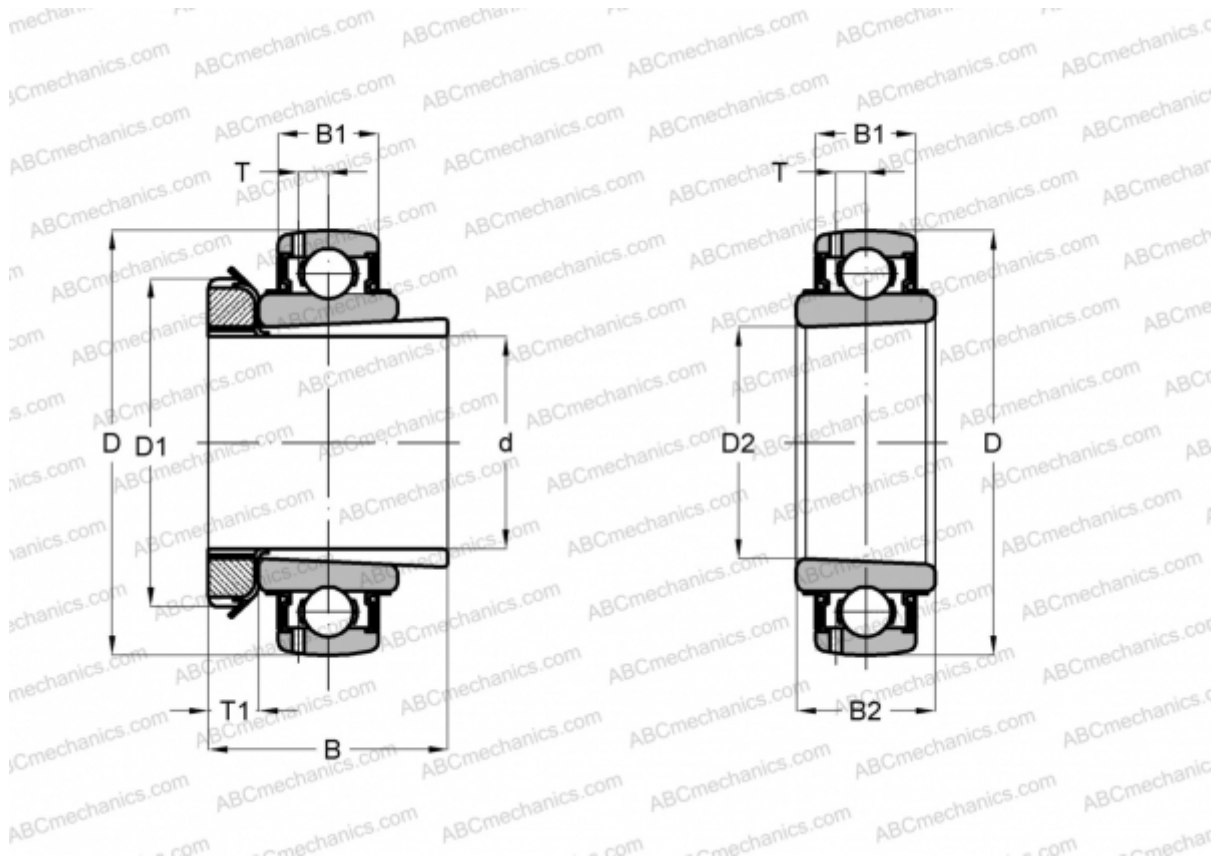

Technical specification

DIMENSIONS, MM

d	44,450
D	90,000
D1	70,000
B	55,000
B1	22,000
B2	37,000

WEIGHT, KG 0,880

MANUFACTURER [SKF](#)

CALCULATION DATA

Basic dynamic load rating, C	35,100 kN
Basic static load rating, Co	23,200 kN
Fatigue load limit, Pu	0,980 kN
Limiting speed	4000 r/min

ASSOCIATED PRODUCTS

HE 2310