

## STO 6 ZZ TORRINGTON

Yoke type track roller

TYPE: Roller bearings, Yoke type track rollers, Without axial guidance, Outer ring without ribs, shields 2Z, With an inner ring

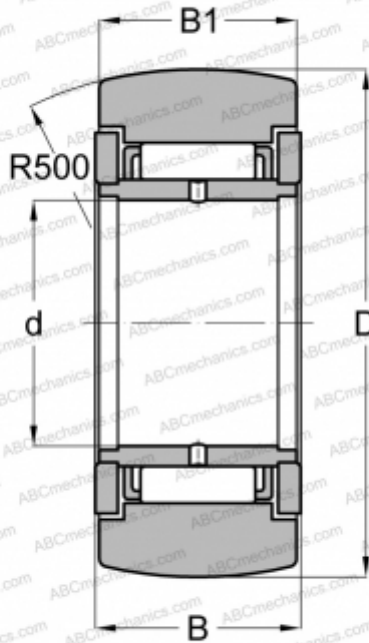

### Technical specification

#### DIMENSIONS, MM

d	6,000
D	19,000
B	14,000
B1	13,800

#### WEIGHT, KG

0,027

#### MANUFACTURER

[TORRINGTON](#)

#### INTERCHANGE

ABC	<a href="#">STO 6 ZZ</a>
FAG	<a href="#">STO 6 2Z(NAST 6 2Z)</a>
SKF	<a href="#">NAST 6 2Z</a>
IKO	<a href="#">NAST 6 ZZR</a>