

STO 8 2Z(NAST 8 2Z) FAG

Yoke type track roller

TYPE: Roller bearings, Yoke type track rollers, Without axial guidance, Outer ring without ribs, shields 2Z, With an inner ring

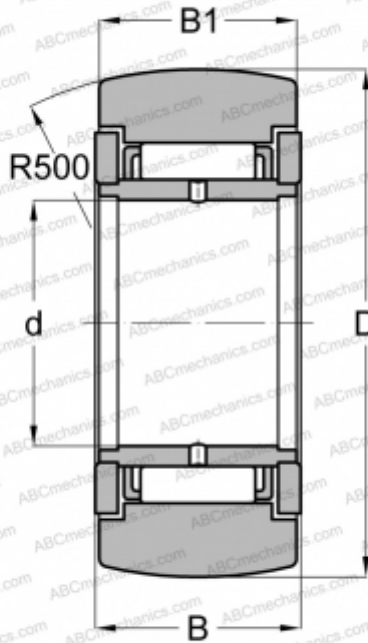

Technical specification

DIMENSIONS, MM

d	8,000
D	24,000
B	14,000
B1	13,800

WEIGHT, KG

0,041

MANUFACTURER

[FAG](#)

INTERCHANGE

ABC	STO 8 ZZ
SKF	NAST 8 2Z
TORRINGTON	STO 8 ZZ
IKO	NAST 8 ZZR